



Ye Olde
Tri TOWNSMAN Valley
"The Best Journal Published by a Dam Sitz!"

VOL. 17 NO. 5 GRAHAMSVILLE, NY 12740 FEBRUARY 4, 2021 \$1.00

Mysterious Book Report John D. McKenna Pg 5 • *The Olive Jar* Carol La Monda Pg 6 • *The Scene Too* Jane Harrison Pg 11
Knarf's Classic Movie & Trivia Pg 30

UC Executive Ryan Announces Additional Funding to Support Food Pantries as a part of the next phase of Project Resilience, County Executive Ryan announces funding to go towards local food pantries

This funding will provide roughly 120,000 additional meals for residents bringing the total meals through Project Resilience to nearly half a million

KINGSTON, N.Y. - County Executive Pat Ryan is pleased to announce that Project Resilience has awarded additional funding to address food insecurity and youth programming in the wake of the COVID-19 pandemic by providing support for local food pantries. Project Resilience will be granting \$80,000 to 16 pantries across Ulster County to help support the surging needs that pantries are seeing this winter. Additionally, Project Resilience will be partnering with the YMCA to launch a new drop-in childcare program in Ellenville.

Project Resilience surveyed every pantry in Ulster County and asked how their operations had been impacted by COVID-19. The average pantry has seen its clients double and has been facing shortages of volunteers. These grants ranging from \$3,000-\$8,000 per pantry will help them increase their services. We anticipate that 120,000 additional meals will be provided through this additional funding. (Contd. Pg. 4)



County Executive Ryan visits the Plattekill Food Pantry.

New Hope Community Announces Promotion of Karen Russell to Chief Operating Officer



Loch Sheldrake, NY (January 26, 2021): New Hope Community, a leading agency supporting the needs of people who have intellectual and other developmental disabilities, announced today that Karen Russell, Senior Vice President of Clinical and Regulatory Operations has been promoted to the role of Chief Operating Officer, effective January 3, 2021. Russell has a distinguished 25-year career at New Hope Community and her broad knowledge of the human services industry encompasses regulatory, compliance and quality assurance responsibilities as well as health services and residential operations. In her new role, she will lead New Hope Community's ongoing operational growth and oversee the development and implementation of industry-leading strategies and initiatives to further the organization's mission and vision.

"Karen is a proven, results-driven leader who has built solid relationships throughout our organization and within the human services industry as well as in the local community," said Debbie McGinness, Chief Executive Officer, New Hope Community. (Contd. Pg. 12)

YE OLDE TRI-VALLEY TOWNSMAN

OFFICIAL NEWSPAPER FOR
THE TOWN OF DENNING AND
THE TOWN OF NEVERSINK

Ye Olde Tri-Valley Townsman (USPS #009 398 - ISSN 1558-9013) will be published weekly for \$40.00 per year by **Gnome Home Inc.**

EDITOR: Linda Comando - 985-0501

NEVERSINK NEWS: Hulda Vernoooy

THE SCENE TOO - Jane Harrison

OLIVE JAR - Carol La Monda

MYSTERIOUS BOOK REPORT - John McKenna

HER QUIRKY JOURNEY - Marilyn North

FALLSBURG NEWS - Larry Schafman

MOVIE TRIVIA - Frank Comando a/k/a Knarf

Email: tvtownsman@yahoo.com

Website: thetownsman.com

Subscription for *The Townsman* will be available in pdf format and will be delivered to you each week in your email that will be provided by you. *The Townsman* can easily be read on a computer, tablet or cell phone. The pages have been formatted so they can be printed out as a whole paper or a single page. We continue to encourage those who have home printers, to print out a hard copy and perhaps pass it on to a family member or friend who does not have a computer.

.....
**POLICY ON SUBMISSIONS AND
LETTERS TO THE EDITORS:**

1. **ALL submissions** should be typewritten or in Microsoft Word.
2. Letters should contain no more than 300 words and must be typewritten. They may be emailed as Microsoft Word documents.
3. Letters should offer worthwhile comments and avoid libel or bad taste.
4. Letters must be signed with the writer's own name. No letter will be published without a signature.
5. The writer must provide his/her full name, address and telephone number (for verification). This information will be kept on file in the Gnome Home Inc. office. Telephone numbers will not be published.
6. Copies of letters or third-party letters will not be accepted.

Opinions expressed in *Ye Olde Tri-Valley Townsman* belong to the writers and are not necessarily the viewpoint of *Ye Olde Tri-Valley Townsman* or its staff.

To renew or receive a new subscription to the *Virtual TOWNSMAN*, in your email every week, fill out the form below and mail it to Townsman, P O Box 232, Grahamsville, NY or drop it in the box located on the porch of the First Aid Building in Grahamsville. Make checks payable to: *Ye Olde Tri-Valley Townsman*. You may also sign up on line and pay with **Paypal** from the website: thetownsman.com

NAME _____
ADDRESS _____

EMAIL _____
PHONE _____

SUBSCRIPTIONS: **\$40.00 PER YEAR**

NEW _____ RENEWAL/DATE EXP. _____

Check # _____

Subscription/renewals must be received by the last Saturday of the month preceding your renewal date to avoid interruption of your subscription.

A change of an email address must be received a month prior to change in order to make the necessary changes in our computer system. All changes are the responsibility of the subscriber.

ADVERTISING RATES are based on \$2.50 per sq. in .

**ADVERTISING DEADLINE:
3:00 P.M. FRIDAYS - FIRM**

Rates are based on **Camera-ready copy. All advertising must be pre-paid** unless other arrangements have been made.

Please send your ad copy to: tvtownsman@yahoo.com or by regular mail to: **The Townsman**, PO Box 232, Grahamsville, NY 12740

Deadline for all submissions is 3:00 p.m. Friday for the following week's issue

NO EXCEPTIONS. All press releases/article sent by email should be sent as **Microsoft Word Documents**. Photos or graphics must be in jpg format

More than ever, thank you for your support during these difficult times. Wishing everyone well.

ON THE FRONT BURNER:

I will call upon the Lord, who is worthy to be praised: so shall I be saved from mine enemies. Psalm 18:3

OBITUARY

Arlos R. Every, 1930-2021/ Born in West Shokan, NY on May 30, 1930, Arlos "Bucky" Every grew up on a farm in the midst of the Great Depression as one of seven children of the late Francis Every and Delta Nichols Every.

He married his beloved wife of 62 years, Vivian Angevine of Bearsville, NY, just prior to entering the Army in the early 1950s. He served two years with an 18-month tour in post-WWII Germany. After his honorable discharge, he rejoined his wife and embarked on an entrepreneurial career when the trucking company he had worked for prior to entering the Army refused to recognize his seniority.

Among numerous successful ventures involving forestry, real estate, and the contract transportation of mail, he started a school bus company in the early 1960s that became known as Tonche Transit, Inc. With the help of Vivian, he grew his fleet from one bus to more than forty, entered the motorcoach business in the 1980s, and acquired another school bus operation, RJW Transit, in the 1990s, which became EVCO Transport, Inc.

Joined by his son, Glenn, in 2000 and daughter, JoAnne, in 2009, he expanded the business into a regional interstate motorcoach operation while continuing to serve local school districts with school buses. Tonche Transit has been recognized by the NYSDOT and the insurance industry for their safe operation on numerous occasions, and the company was recently profiled on CNBC and in the New York Times. Arlos remained active in the business on a daily basis until a week before his passing.

He was an avid outdoorsman who enjoyed travelling and camping with his wife. He was a motorsport enthusiast from his early days building, owning, and sponsoring race cars. His 12th-place finish at the 1952 Daytona 150 was one of his most memorable moments, and at the last race he ever attended, he watched his son and grandson win at the 2020 Lime Rock Historic Festival.

Arlos is best viewed through the lens of the family and friends in the community that he touched. He was always there for his siblings when they needed a hand and spent a lot of time caring for his brother Harvey. On a personal note, my father was also my closest friend, the

best man at my wedding, my business partner, daily companion, and most importantly, the finest example of how to be a man. The special bond he shared with my sister was one to be admired. He truly was her hero. A strong supporter of the activities of his family, he could often be found at horse shows, sporting events, gymnastics meets, and concerts. He instilled honesty, a strong work ethic, and the importance of education in his children and grandchildren, all of whom received college degrees. He also supported the arts through an artist-in-residence program at his former home in Wittenberg that nurtured young artists who are now making their own impact on the world.

There are two comments that stand out in the many condolences we have received that perhaps capture his essence best: He was a giant of quiet, strong Americanism; and, He lived life on his own terms and showed no fear.

With the passing of the love of his life, Vivian, in 2014 Arlos moved in with his daughter JoAnne Bachor of Boiceville, NY. He leaves behind his daughter JoAnne, and son, Glenn Every of Rhinebeck, NY; grandchildren Heidi Bachor, Heather Bachor, Holly Bachor, Matthew Every, and Sam Every; great grandchild Philanthe LaMonda; and his beloved dog, Molly. He is survived by his sisters Alma Ronk, Evelyn Morton, Marilyn Higley, and Beverly Kelder; and first cousins: Lynn Krebsler, Doris Glass, Raymond Nichols, Gail Alexander, and Wayne Nichols. His brothers Don and Harvey predeceased him.

He passed away peacefully at home surrounded by his family on January 23, 2021.

A graveside memorial service will be held in the Spring. The family suggests memorial contributions may be made to Hudson Valley Hospice at www.hvhospice.org You may share a special memory or condolence with the family on Bucky's Tribute Wall at gormleyfuneral-home.com Funeral arrangements are under the direction of the E. B. Gormley Funeral Home 87 Main St. Phoenicia.

COLLEGE NEWS:

Alexa Wakefield has made the Dean's list every semester of her four years at college. Her family is very proud of her. We are sure her Grandpa Wakefield is especially proud. Alexa's major is Art Therapy.

DAYS OF YORE....**Today's History****January 31, 1951**

According to a story in last week's Liberty Gazette, 2,000 deer hides have been collected and shipped by truck from Sullivan County to Gloversville, N.Y. where they will be used to manufacture gloves for U.S. Airmen. Most of the hides were from deer shot by Sullivan County hunters last fall. The shipment was valued at around \$10,000.

Mrs. Lucy Kortright Frear, 79, wife of Jacob Frear of Liberty, died at her home on Monday morning, January 29th. She was born near Neversink on August 7, 1871, the daughter of Abram and Phoebe Dean Kortright. Surviving are her husband; a brother, Asa Kortright of Liberty and a sister, Mrs. Herbert Smith of Buffalo.

February 1, 1961

Marine Pvt. Willard A. Graham, son of Mr. and Mrs. William Graham of Grahamsville, has completed recruit training at the Marine Corps Recruit Depot, Parris Island, S.C.

A group of 25 Future Farmers of America members were raised from green hand status to chapter farmers at a recent Tri-County FFA meeting at the Middletown High School. Sullivan County members were: David VanValkenburg, David Denman, Michael Dean, Vernon Turner and Richard Carr.

Fred Dolloway, a life resident of Claryville, died at his home. He was the owner of a general store and gas station in Claryville. Mr. Dolloway was born February 9, 1903 in Claryville, the son of Henry C. and Lizzie Dulaff Dolloway. Surviving are his mother, Mrs. Lizzie Dolloway; a brother, Clyde and a sister, Mrs. Percy Cole all of Claryville.

Mr. and Mrs. Delso Edwards of Kingston, N.Y. celebrated their 50th Wedding Anniversary on January 29th. They were married in Grahamsville on January 29, 1911. Mrs. Edwards is the former Iona Krum.

February 3, 1971

Tri-Valley Central School's 1971 Betty Crocker Homemaker of Tomorrow is senior Robin Marshalek. Robin will receive a specially designed award from General Mills, sponsor of the annual education program. Robin is the daughter of Mr. and Mrs. John Marshalek of Woodbourne.

Miss MaryAnn Murphy has been notified of her acceptance at the State University at Cortland. She is the daughter of Mr. and Mrs. John Murphy of Grahamsville. Miss Murphy plans to major in physical education.

Mr. and Mrs. Joseph Levy announce the engagement of their daughter, Miss Ginger Levy to Stanford David Miller, son of Mr. and Mrs. Raymond Miller of Napanoch. Ginger is a Tri-Valley graduate and is attending UCCC in the Nursing Program. David is a graduate of Ellenville High School and has been accepted at UCCC. A June 19, 1971 wedding is planned.

January 29, 1981

The Grahamsville General Store has changed ownership as of January 1, 1981, to Bill and Jan Davies of Sundown. The former owners were Cathy and Joe Levy.

Mrs. Bertha Ackerley, whose 83rd birthday was Sunday, January 25th, was pleasantly surprised with a party in her honor at the meeting of the Claryville Ladies Aid last Tuesday.

Household Hints:**Skunks are Waking Up, too**

Not only groundhogs are waking up, so are the skunks. If your dog should have a run-in with a skunk, vinegar will take care of the smell better than even tomato juice. Using vinegar diluted 50% with water, rub the dog's fur. Rinse with warm water. Repeat as needed.

Nature Column - Linda Comando

A tribute to the memory of all of the Townsman Ladies that we have lost and loved so much... Peggy DeWire, Avril Pappa, Joan Hall, Polly Hill, Joyce Lockhart, Jean Helthaler, Karen Curry and Barbara Slater.

Will the Storm Pass Over Punxsutawney, PA?

With the pending snowstorm it looks like Punxsutawney Phil probably won't see his shadow on Ground Hog Day this year.

According to folklore, if it is cloudy when Punxsutawney Phil, the famous groundhog, emerges from his burrow on February 2, the midway point of astronomical winter, then spring will come early.

After the male groundhog wakes up on this middle of the winter day, he will shuffle over several acres of his territory and check on burrows containing females. He ducks inside each one to cuddle for the night and leaves the next morning to continue the tour.

He doesn't mate on these getting-to-know-you visits. At the end of his walk-around the male groundhog returns to his own burrow, curls up into a furry ball and goes back to sleep for another month of hibernation.

Groundhogs or woodchucks wake up for good in late March to mate and then lead solitary lives. In April 2-6 babies are born naked and blind after a month gestation. The litter matures by autumn and lives 4-5 years if it escapes hunters, hawks, foxes and coyotes.

Groundhogs (*Marmota monax*) grow to twelve pounds and two feet long. They're brownish yellow furred animals with black feet and a short tail. Their flat top skulls with eyes and ears that are set low are perfect for not exposing much of their heads to poke above ground. This rodent's incisors never stop growing and can become a fatal danger unless kept worn down with constant chewing. Although groundhogs mostly graze on grass, they can climb trees and swim to forage for greenery.

They feed at sunrise and sunset, keeping out of sight during daylight hours. Groundhogs are forever alert to danger, and will race back to their burrow as they sound a shrill alarm whistle that earns them the nickname "whistle pig."

A groundhog digs a burrow 10-15 feet long with a front entrance, spy holes, a toilet chamber and a comfortable nest room for sleeping or a nursery.

The name woodchuck comes from the Indian legend of "Wojak, the groundhog" considered by them to be their ancestral grandfather.

In 1723, the Delaware Indians settled in Punxsutawney, Pennsylvania. The Delaware considered groundhogs honorable ancestors. The name Punxsutawney comes from the Indian name for the location "ponksad-uteney" which means "the town of the sandflies."

During that same time when the German settlers arrived in Pennsylvania during the 1700s, they brought a tradition known as Candlemas Day, which had its origin in the pagan celebration of Imbolc. If the sun made an appearance on Candlemas Day, an animal would cast a shadow, thus predicting six more weeks of Winter. Germans watched a badger for the shadow, however, once in Pennsylvania where there were no badgers, they adapted the new tradition of watching a Groundhog.

Happy Ground Hog Day!



Ulster County Executive Ryan Announces Additional Funding to Support Food Pantries as a part of the next phase of Project Resilience, County Executive Ryan announces funding to go towards local food pantries

(From Pg. 1) Project Resilience is also partnering with the YMCA to help sponsor a new drop-in child care program for kids in grades K-6 in Ellenville. This program will begin on February 1st to support working parents in Ellenville. Ellenville School District has been in need of a child care program and afterschool program for youth even prior to the pandemic. COVID-19 has intensified this need, with the YMCA licensed by the Office of Children and Family Services (OCFS) last year to operate a child care program at the Ellenville Elementary School, Project Resilience wanted to help provide greater access to the program and facilitate the opening of the Y's program.

"As County Executive, I am committed to ensuring that our residents are given the resources and food they need during this critical time," County Executive Pat Ryan said. "This additional funding, secured through Project Resilience, will allow us to support our local food pantries in feeding more residents who have been impacted by this pandemic. I am grateful that we are able to support more youth programs and food programs at this time of need."

"We greatly appreciate this partnership with Ulster County Project Resilience and the United Way of Ulster County, this is a great example of our government working together with community organizations to meet a community need, said Heidi Kirschner, CEO and President of the YMCA of Kingston and Ulster County. "We are happy to help provide child care for so many families who have needed this type of program for far too long."

"We have had a great increase on the number of families that depend on us," Charlotte Knapp, Rondout Valley Food Pantry said. "At one point during the summer, we coordinated with County Executive Pat Ryan's Office for Project Resilience and served all but two townships in our county via delivery only. If we did not increase the frequency of our days we are open, or the number of times a guest may receive groceries in a week our community would have been affected even more so than they already are."

"We are seeing people at the Pantry who have never had food insufficiency before and the number of people we are serving is almost double," Reverend Childs from Pointe of Praise Family Life Center Pantry said. "We are so blessed to have our community stepping up through Project Resilience to support us this winter."

Pantries Receiving Funds Include:

People's Place; The Table at Woodstock; Hunger is Not an Option; Rondout Valley Food Pantry; Pointe of Praise Family Life Center Pantry; Town of Rochester Food Pantry; Ascension Holy Trinity Mission Center Food Pantries; New Day Food Pantry; Family of New Paltz; Loaves and Fishes Food Pantry; St. Charles Helping Hands Food Pantry; Plattekill Food Pantry; Good Neighbor Food Pantry of Woodstock; Family of Ellenville; Hodge Center; and Family of Woodstock

Project Resilience provided support for these programs in the fall and is continuing funding through the winter to

support local youth and families impacted by the pandemic through an additional round of funding to Center for Creative Education, The Boys and Girls Club and the YMCA so that they can continue to offer tuition assistance to families in need.

As the needs of our county evolve over the winter, the County will continue to re-imagine Project Resilience to meet the needs of the Ulster County community. Project Resilience is made possible through partnerships with the United Way and Community Foundations.

Launched in March, Project Resilience started as a community fund and local food distribution efforts established to support residents impacted by COVID-19. Within 24 hours of its inception, County Executive Ryan secured over \$2 million dollars in funding and announced partnerships with municipal governments, local businesses, and not-for-profits. Since launching, Project Resilience has provided nearly 300,000 meals while supporting over 100 small businesses.

Please call 845-338-3810 ext. 122 for more information about Ulster County Project Resilience financial aid for the Y Academy at Ellenville Elementary or contact Cailin Rooney at Crooney@ymcaulster.org or Jhaunelle Anderson at Janderson@ymcaulster.org.

Donations are accepted here through the United Way of Ulster County. For more information on Project Resilience, please visit: <https://covid19.ulstercountyny.gov/project-resilience/>

Virtual Mentoring and Training

Offices around the country may be closed due to the pandemic, but SCORE, Small Business Development Centers, Women's Business Centers, Veterans Business Outreach Centers and other resource partners are providing free business mentoring and training by phone, email, and video. For more information go to:

https://www.sba.gov/localassistance?utm_medium=email&utm_source=govdelivery

Federal Coronavirus Resources

State, local, and federal agencies are working together to maintain the safety, security, and health of the American people. Check out <http://coronavirus.gov> for updates from the White House's COVID-19 Task Force. Go to <http://cdc.gov> for detailed information about COVID-19 from the Centers for Disease Control and Prevention. Visit <http://covid-sb.org>, the official federal resource website for U.S. small businesses affected by COVID-19.

Reminder: Deadline to enroll in a health plan through NYS of Health Extended

The deadline to enroll in a health plan through NY State of Health has been extended. If you are uninsured, now is a good time to sign up for quality and affordable health plans through the state marketplace. Learn more at: <https://nystateofhealth.ny.gov/>

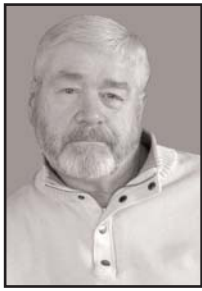

Sirocco

Mysterious Book Report No. 433

by John Dwaine McKenna

With more infighting, back-stabbing and double-crossing than a month-long joint session of Congress, *Sirocco*, (Blackstone, PB, \$16.99, 400 pages, ISBN 978-1-0940-9983-5), the sophomore effort of author Dana Haynes — after 2019s, *St. Nicholas Salvage and Wrecking* — picks up right where the first one left off, with a pulsating sequel.

This time, ex-cop Michael Finnegan and his partner, Katlin Fiero, a Spanish aristocrat with a unique skill-set and elite training that's made her into a world-class assassin, are chasing a mysterious and elusive terrorist group who're responsible for a number of bombings in Europe that have taken dozens of innocent lives . . . including women and children . . . as well as a CIA Chief, her husband, and their toddler daughter.

After each blast, an unnamed Islamic cleric appears in an online video taking credit for the atrocity, while blaming the West, for supporting the government of Alsharq, a small North African country on the Mediterranean. Finnegan and Fiero are tasked with finding the elusive group of terrorists, capturing or killing the leader and stopping the bombings. But the St. Nicholas Salvage & Wrecking crew aren't the only ones trying to put the terrorists out of business. A ruthless American private contracting firm is also on the hunt, with a nearly unlimited budget and resources . . . plus a take-no prisoners philosophy. Add in a few spies, a couple of gangsters and the director of Spain's National Intelligence Service and the plot gets more byzantine with every chapter as it works its way toward a rousing conclusion at a Spanish fortress that will leave readers wondering if anyone will live to tell the tale. If you crave action, adventure and heroes to cheer for, you won't want to miss the adventures of Fiero, Finnegan, and the rest of St. Nicholas Salvage & Wrecking Crew!

Like the review? Let your friends know, *You saw it in the Mysterious Book Report*, because the greatest compliment you can give is to share our work with others.

And Hey! Check out our combined website that's simple to use and easy as pie to leave your comments! We're looking forward to hearing from all of you.

Johndwainemckenna.com or Mysteriousbookreport.com

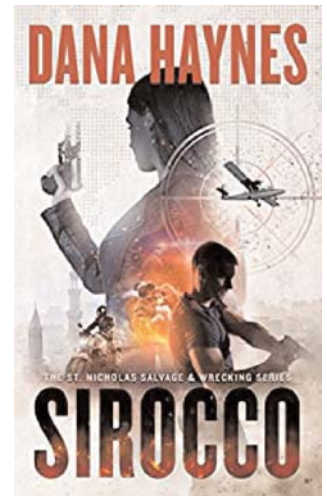

Interview with author: Dana Haynes

by John Dwaine McKenna

Today's interview is with author Dana Haynes, whose latest high octane thriller, *Sirocco*, is reviewed above in MBR No. 433. He's the true professional; a writer who's hard-working, dedicated to the craft, and possesses an intimate knowledge of the inner workings of a great story. And, best of all he's willing to share his knowledge with all of us.

With many thanks Mr. Haynes, here's our first question . . .

Where do you write?

I "grew up" in newspaper newsrooms, so I need a certain level of cacophony around me to be productive. Total quiet drives me nuts. Before the pandemic, I loved going to coffee shops, especially ones near or in bookshops. With social distancing, I've created a nook in my apartment, one specific chair, that's my "writing station." I also listen to the soundtracks of thriller movies when I write. If I'm writing a chase scene and I've got John Powell's score from "The Bourne Identity" playing, wow: I'm totally focused on the chase.

Why do you write?

I literally can't help it. I write my novels for me as the first reader. I'm the one I'm trying to entertain. True story: Between my third and fourth novel, I had a, ah, "dry period," shall we say, of 15 years. During those years, I just could not get published. But I wrote damn near every single day during that time. The worst hour I ever spent writing beats the best hour I ever spent at my first grown-up job, as a janitor at a car dealership.

How long, start to finish, do you take to write a finished novel, on average? Do you have a daily writing goal you shoot for?

I'm very fast. That's not a brag, it's just that I have worked as a print journalist since high school and we're fast writers. You go to a City Council meeting, come back and hammer out exactly the right length of story to fill the space your editor gave you.

(Contd. Pg.

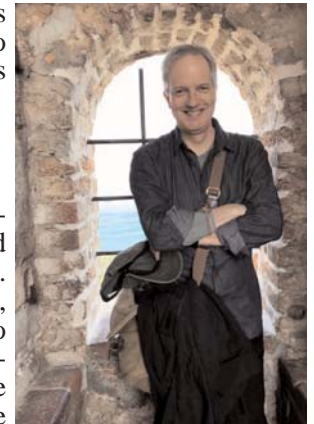

John Dwaine McKenna's Books are now available at the NEVERSINK GENERAL STORE



DENMAN CONSTRUCTION

Builders of Fine Custom Frame & Log Homes

Additions & Renovations

Heavy Equipment Work

Septic Systems

Drainage Work

Stone Work

Fireplaces

Flood Damage Repair



General Carpentry

Interior & Exterior

Painting & Staining

Tile Work

Wood Floors



Driveways

Road Building

We Build the American Dream

Poured Concrete Foundations

Complete Site Work

Rick (845) 985-2212 DEC Approved Flood Control Contractor **Jim (845) 647-4059**
denmanco@hvc.rr.com

The FamilyMemoir, PROSILIO...

... in Greek means "Toward the Sun," was written by Carol Olsen LaMonda. Carol writes the column "The Olive Jar" for *Ye Olde Tri-Valley Townsman*. This local author has been busy guesting at book clubs who have chosen this local memoir as their book choice. **Feel the warmth of "Prosilio" as you read Carol's memoirs cuddled up in your favorite chair. It also makes a great gift!** *Prosilio* is available at Amazon or Barnes and Noble on-line as a soft or hard cover or as a downloadable e-book for Nook or Kindle. Go to: <http://amazon.com> or <http://barnesandnoble.com> and type in *Prosilio* in the search to order your copy of *Prosilio*



Fully Insured **Free Estimates**

DEAN CONSTRUCTION & HOME IMPROVEMENT CORP.

We provide professional installation of
 Roofing, Siding, Windows, Doors,
 Decks, Seamless Gutters and so much more

(845) 985-2398

Erts Mechanical, Inc.

d.b.a. Erts Plumbing, Heating & Air Conditioning

Specializing in:	Plumbing	Solar
	Heating	Dx Geothermal
	Air conditioning	Radiant heat
	Buried water & sewer	Water Pumps

Established: 1956 Bonded & Insured

John G. Erts – President Phone: (845) 292-4571
 21 Jordan Ave. Fax: (845) 292-8142
 Liberty, NY 12754 e-mail: johnerts@ertsplumbing.com



The Olive Jar

By Carol Olsen LaMonda

Bucky

The Wheels on the Bus
 Go Round and Round,
 Round and Round,
 Round and Round...

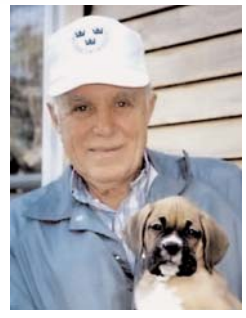

This week Arlos R. Every left us, but "Bucky" as everyone knew him, will remain in the minds and hearts of our community as a local legend. Bucky operated TTI, Tonche Transit, and EVCO Motor-Coach company in Mount Tremper. Most people just shortened it to TONCHE as the way one would refer to his business that he started in 1960 with his beloved wife Vivian. Many made it even more personal by proudly saying, "I drove for Bucky" or "I rode with Bucky". The wheels of his buses brought students to school, athletes to meets and games, seniors to casinos, camp counselors to local businesses, guests to weddings, and groups on adventures all around the state.

One time a little boy dozed off in the back of the bus missing his stop. Bucky discovered him asleep and gently roused him and drove him home to his parents. That little boy was my grandson.

Bucky had a thing for wheels and things that moved. He drove buses; he drove RV's; he drove Quads; he drove race cars; he drove plows; he drove wave-runners; he drove snowmobiles.

He loved things that went Vroom! He was Nascar's biggest fan. He placed twelfth at the 1952 Daytona 150, and loved watching his son and grandson win at the 2020 Lime Rock Historic Festival Race.

He was a homegrown patriot, a veteran, an entrepreneur, an outdoorsman, a lover of animals, and gentleman who could stand up for his beliefs with a rare mix of courage and courtesy. He never retired because working alongside his son Glenn and daughter JoAnne was also his passion. Yes, Bucky loved wheels. Those wheels were the hub of the community he served. He especially loved the wheels of his big Suburban that he would drive, dog beside him, to his cabin on the lake, to races, and to family dinners and celebrations because the only thing he loved more than wheels was family.

The Wheels on the Bus
 Go Round and Round,
 All Around the Town!

Note to everyone. Bucky is JoAnne Bachor's dad,, my daughter-in-law Heather's grandfather, and Philanthé's great-grandfather. He was loved and will be remembered by all who were fortunate enough to know him.

Napanoch Appliances
~ Sales and Repairs ~

845-532-0789 845-210-1100

JAMES'
General Store

Save time... Call your order in!
 Main Street • Napanoch
647-5973

Open 7 Days • 6 AM to 7 PM
 • Breakfast 6 am- 11 am

Coffee
 Cappuccino
 Hot Chocolate
 • Lunch Specials
 • Deli Sandwiches
 • Hot Sandwiches
 • DVD Rentals •

ATM Machine



SHEELEY OIL & EXCAVATING INC

Driveways Septics Excavating & Bulldozing

P. O. Box 255
 Claryville, NY 12725
 PHONE: 845-985-2231
 FAX: 845-985-0186

Fuel Oil Kerosene Budget & Pre Pay Plans

Email: suesheeley@gmail.com
<http://www.sheeleyexcavating.com>



Matthews Pharmacy
Professional Personalized Service

Continuous Operation Since 1858
Prescription Specialists

School Supplies, Greeting Cards, Gifts, Walkers,
 Canes, Ostomy Supplies, Nebulization Supplies

Home Diagnostic Specialists

845-647-6222
Fax 845-647-1558

Vitamin & Nutrition Center

101 Canal St., Ellenville
HOURS:
 Mon - Fri 9 am - 6 pm
 Sat 9 am - 3 pm
<https://matthewspharmacy.com>



DO IT CENTER

Distributors of Quality Building Supplies

Alside Vinyl Products, U.S. Plastic Lumber, Superseal Vinyl Windows, Survivor Vinyl Windows, Weathershield Windows, Therma Tru Doors, Fabral Metal Roofing, Atas Commercial Metal Roofing, Seamless Gutters, Dietrich Metal Wall Systems, Dow Foam Insulation, Guardian Fiberglass Insulation, Cedar Pressure Treated and Common Lumber and Wood Sidings, DeWalt Power Tools. Do it Best Paint, Hardware and More.

**Call Today For The Quote
 On Your Next Building Project**

(845) 985-7693 • Fax: (845) 985-7697

Web: <http://www.supbldsup.com>

Open Mon.-Fri. 'til 5 P.M., Sat. 'til 1 P.M.
Rte. 55, Mutton Hill Rd., Neversink, NY 12765

**Sullivan County Treasurer and Sheriff
 Announce Re-election Bids**

Sullivan County Sheriff Michal Schiff and Sullivan County Treasurer Nancy Buck intend to announce the start of their re-election campaigns.

Michael Schiff, a Liberty native and former 28 year state trooper, was first elected Sheriff in 2006, succeeding retired Sheriff Dan Hogue. Mike Schiff who is running on the campaign slogan "Law Enforcement for the 21st Century", he has modernized the Sheriff's Office with the latest training and equipment to keep both the public and his deputy sheriffs safe.

Nancy Buck is running for her second full term as County Treasurer. She was appointed to the position in 2014 to fill a vacancy after the death of then-Treasurer Ira Cohen. Buck then ran in 2015 to finish the unexpired term and ran for the full four year term in 2017.

Nancy Buck, Sullivan County Treasurer served as Deputy Sullivan County Treasurer from December 2000 to December 2014, and elected County Treasurer in November 2015 & 2017. She is a member of New York State Association of Counties (NYSAC) and serves on their Finance and Economic Development Committees and has taught classes for NYSAC and is an Executive Board Member of the NYSAC Women's Leadership Council. Buck is a member of the Government Finance Officers Association and Officer and Member of NYS County Treasurers and Finance Officers Association and has been awarded the prestigious Certificate of Achievement for Excellence in Financial Reporting by the Government Finance Officers Association every year. She is a graduate of the County Government Institute, a collaboration between NYSAC and Cornell University. Buck has prepared the County's Fund Balance Policy, Investment Policy and Debt Management Policy and is a Board Member of the Sullivan County Land Bank. She is a Board member and lifetime advocate of Donate Life, a national organization focused on organ, eye and tissue donation.

985 - 2941



PERMA FIX
PLUMBING & HEATING

New Construction
 Heating Systems
 Water Systems

Licensed - Insured - Guaranteed
SIMPLY THE BEST

DALE DONOVAN - Prop.
 GRAHAMSVILLE, N.Y. 12740

New York State COVID-19 Vaccination Center



Forest Ranger Gullen at the SUNY Albany Mass Vaccination Site

On Jan. 9, two Forest Rangers were deployed to assist the State's efforts to stand up a mass vaccination site at the SUNY Albany Campus. Forest Rangers fill critical roles in the Incident Command System (ICS) structure that are crucial in the success of the mission, including serving as Operation and Planning Section Chiefs. On Jan. 15, the mass vaccination site was established, capable of handling more than 1,000 patients a day. At this site and others across the state, Rangers are joined by other DEC staff from more than a dozen divisions, as well as representatives from multiple state agencies



BLOOMING GREEN
LAWN AND LANDSCAPE SERVICE

Ben Knight
845-985-0516 • 845-665-3348

Fall Cleanups
Firewood
Buy from the best
Don't be undercut by the rest

Pruning
• Shrubs • Fruit Trees • Ornamental Trees

Custom Complete Lawn Care • Edging
Raised Flowerbeds • Mulching • Light Landscaping
Over 20 years experience
Residential and Commercial
Fully Insured

Check out our website:
<http://www.bloominggreenlawnandlandscape.com>
"If it grows by day, have it cut & split by Knight"

Statement from the Executive Committee of the Sullivan County Democratic Committee

It's pretty curious that in this week, when the County Legislative Chair is pushing hard to install private contractors to take over management of our County owned Adult Care Center, a month's old complaint is raised against the most vocal opponent of the dubious plan, and a "Special Meeting" called to discuss something that would generally be handled in private. Further, it comes one week after that same Legislator switched his political party away from that of the Chair. As the matter is in the hands of Mr. Alvarez's attorney, we will allow a Court to determine the merit of the complaint, meeting and discussion, but we remain undeterred in our support of Legislator Alvarez and his efforts to keep our publicly owned Adult Care Center in the hands of our citizens, and not in the pockets of questionable operators.

We further call on our citizens to stand up and make your voices heard to your legislators. Let them know that this STINKS of petty political retribution. Let them know that opposition voices will not be silenced by partisan complaints to an Ethics Board that seemingly lacks any degree of independent thought and instead acts as a political weapon of the Legislative Chair. Let them know that you DEMAND that this Chair's conduct during his tenure be investigated as well.

Finally, we call on every employee of this County to contact our Committee if you have been subject to unethical or harassing conduct at the hands of the Chairman or member of the County Management. You may email your confidential complaint to ethicscomplaintsscdc@gmail.com and we will help you get the justice you deserve.

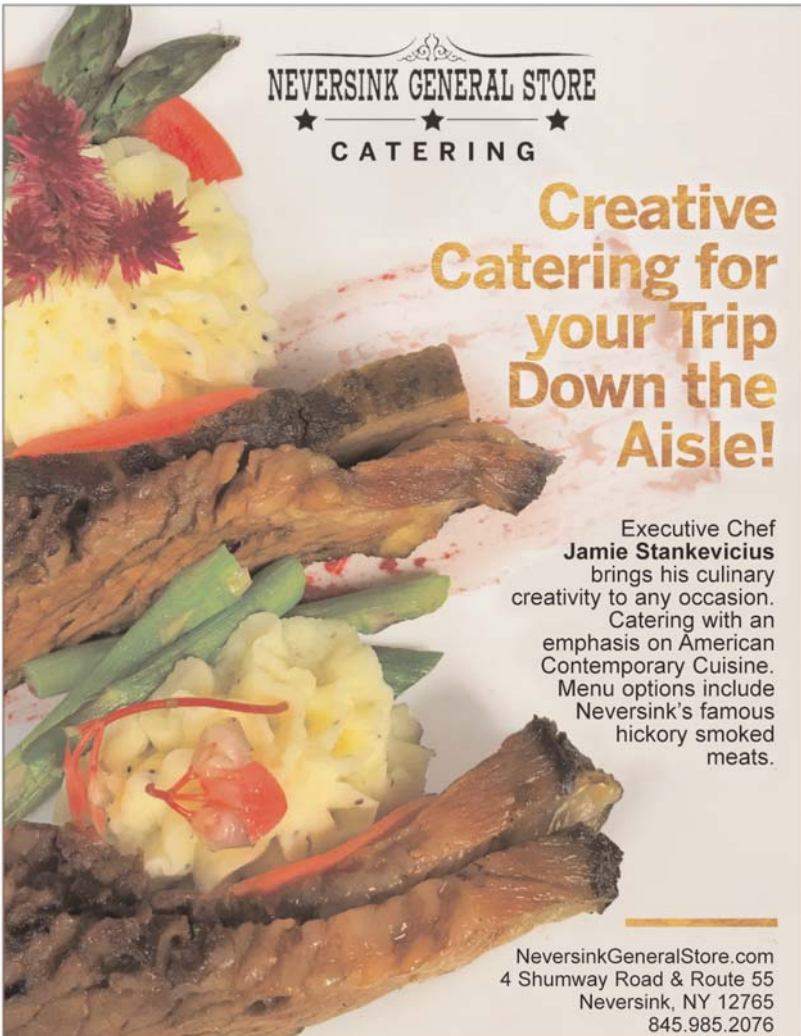

NEVERSINK GENERAL STORE
★ ★ ★
CATERING

Creative Catering for your Trip Down the Aisle!

Executive Chef **Jamie Stankevicius** brings his culinary creativity to any occasion. Catering with an emphasis on American Contemporary Cuisine. Menu options include Neversink's famous hickory smoked meats.

NeversinkGeneralStore.com
4 Shumway Road & Route 55
Neversink, NY 12765
845.985.2076



Valentine's Day Card Event

for ALL ages

Want to make your heart smile too?

Join us in making homemade cards for our local nursing home residents at the Care Center! Help us spread a little bit of kindness to our senior community members.



DIY Valentine's Day cards will be available (while supplies last) for curbside pick-up starting Friday, February 5th through Thursday, February 11th during our current operating hours.

Please return cards to the **red box** outside the library by Friday, February 12th, by 3 p.m. for our special delivery.

Thank You!



Daniel Pierce Library

328 Main Street | P.O. Box 268
Grahamsville, New York 12740-0268 | 845-985-7233
www.danielpiercelibrary.org

RA Mickelson & Son LLC

Quality work to last a Lifetime

est.1972

custom homes additions, renovations all phases of construction



Patrick Mickelson
(845)434-5176 home
(845)807-8363 cell

www.ramickelsonandson.com
6673 State Route 42 • Woodbourne, NY 12788
<http://www.ramickelsonandson.com>



Conklin's General Contracting

- Backhoe & Dump Truck • Roads & Driveways •
- Septic Systems • Site Clearing • Water/Sewer/Electric •
- Lines • Snowplowing •
- Topsoil & Stone • Sand & Gravel •

Call PAUL – (845) 985-2844
McGuire Road, Neversink, NY



Providing quality insurance at an affordable price since 1867!

Let us help you protect what matters most with our complete range of commercial and personal insurance services.
Call us today (845) 647-9100

116 Canal Street, Ellenville NY
www.sprague-killeen.com



Snow Plowing
Woodie Cyr

Grahamsville, NY
And Surrounding Areas

Cell: (845) 943-0024
Home: (845) 985-2003

10th plowing 50% off



Senator Martucci Statement on NYS Attorney General Report

“I appreciated Attorney General Leticia James' report concerning the failure of the New York State Department of Health (DOH) to adequately protect our seniors living in nursing homes from COVID. Her report clearly indicates that DOH engaged in a cover-up in order to underreport the tragic death toll. However, what the AG's lengthy report did not do was attempt to hold anyone in government accountable for what occurred. Only two pages of the report were dedicated to the Department of Health's failures. Just recently, our Attorney General filed a political lawsuit against the NYPD, but yesterday she demonstrated that she feels no inclination to use her office's considerable powers under the law to investigate a real crime and cover-up. We have heard enough words, now is the time for action. Therefore, today, I will be signing a letter to our Congressional delegation with my colleagues asking for an immediate update on the investigation by the United States Department of Justice into the DOH handling of this matter.

“I am also calling on the Attorney General to do much more than merely issue a report or punish a small number of nursing homes for violations. The Attorney General should use the full and significant powers of her office to subpoena the Department of Health, Commissioner Zucker, and anyone else who may have information about this situation. We need to know about any conversations surrounding the issuance of the DOH directive to nursing homes to accept COVID positive patients and investigate the cover-up that followed. The families of those who died deserve justice, and justice will only come after the truth is revealed and those responsible are held to account.”

The Scene Too

- Jane Harrison

I'm sitting here, writing this on Sunday evening, not knowing whether I'll have power or internet over the next few days. Not snowing yet, but snowmeggedon (number 3? 4?) is on its way. My furry barometers seem to be right..again.

Turned out to be a really busy work week and way too cold outside for anyone with breathing problems to venture out. I actually found myself with cabin fever! I found that weird until I thought about it. It's one thing to self contain because of the pandemic but quite another to find yourself confined because it's 4 degrees outside with a wind chill of -12. But I had this plan. Friday, when it was a bit warmer, I would venture out to my organic fruit and veg place in Livingston Manor, then call ahead for take out and swing by CABERNET FRANK'S in Parksville to pick it up. I do enjoy R.J.'s cooking. Yes, that was the plan. Then I took out the garbage and realized that 'a bit warmer' was not going to work for me. Then on Saturday, I found out NICK HEATHEN popped by and along with the enigmatic CASWYN MOON serenaded the dine-inners. I would have loved to see them both. Note to self: When you make a plan, stick to the plan. The garbage can wait another day.

Speaking of garbage, I picked up my mail the other day and found a book in my box. Not SENT to me, it had not gone through the postal system, but had to have been placed there by a worker in my little town. THAT is what I found offensive. 1. Political or religious, I did not ask for it AND 2. If I have to BUY A STAMP to mail a letter, a book should also need this as well. I have not opened it, read it, don't care. I will be contacting the appropriate authorities. How dare °∞THEY°± invade my space! I immediately thought to drop it in the mass mail garbage on the way out, but no, this was wrong. IS wrong. And then I noticed there seemed to be no others around this can. Was I targeted? Who knows. Who knows what this crap book is about.

And now on to this. I can hear you thinking: °∞What fresh hell it this?°± This is a ball of plastic yarn made from ShopRite bags (before we couldn't get them anymore.) I had been working on a mat for under the litter boxes in an open weave crochet that would extend six inches beyond in a carpet like litter-off-the-paw-catcher. Great idea, BUT°. So I put it away because crochet absolutely eats whatever it is being made from and the idea of buying plastic bags, even from the Dollar Store to complete this, did not appeal to me.



I have the three messiest eaters ever. Every night, I have to sweep, vacuum and mop my tiny kitchen and STILL have dried up pieces of wet food and bits of dried food assaulting my bare feet in the morning. Hazzah! I think. I'll make placemats of that plastic yarn! And I am doing so. I can shake the mess off, rinse if necessary (they dry completely in no time) and just mop at night. Again, that's the plan. I'll let you know how it turns out.

Stay strong, stay safe, and stay masked.
Until next time ~.

UC Executive Ryan Announces that Ulster County has Recouped Nearly \$1.6 million in Unclaimed Funds from the Public Defender's Office

Ulster County to recoup \$1,584,022 in unclaimed funds from the Public Defender's Office dating back from 2014 through 2019

These funds were available to the County to provide equitable coverage for defendants in the justice system who cannot provide for their own defense

KINGSTON, N.Y. - County Executive Pat Ryan announced that the Public Defender's Office has submitted the final contract that will close out this administration's effort to recoup funds that went unclaimed from 2014 through 2019. This final contract, which will be before the Ulster County Legislature at their February meeting, will capture an additional \$16,382, for a total of \$1,584,022.

The recouped claims covered expenses such as rent, supplies, staff salaries, and technological investments that occurred during 2014 to 2019. These funds were available to the County to provide equitable coverage for defendants in the justice system who cannot provide for their own defense.

"As County Executive, I have pledged to provide a more responsive and responsible government and to ensure justice for all our County residents," County Executive Pat Ryan said. "Through the recouping of these funds, we are not only protecting our taxpayers but we are continuing to provide much needed services to some of our most vulnerable residents. I look forward to continuing to work with our Public Defender's office to ensure that we can provide justice for all of our residents."

In February of 2019, it was announced that subsequent to a multi-year financial analysis of the Public Defender's Office it was discovered that nearly \$2.5 million over six straight years in expected and budgeted operational revenue from the State had never been received. The discovery came while implementing County Executive Ryan's first budget. The \$1.6 million in recouped funds represents taxpayer dollars that were expended during this period, the additional \$900,000 were budgeted but unexpended funds.

County Executive Ryan is committed to continuing to ensure that safeguards are in place to protect taxpayer dollars. Last year he asked Ulster County Comptroller March Gallagher to conduct a comprehensive review of the past six years of the Public Defender's finances, the report and findings are forthcoming.

New Hope Community Announces Promotion of Karen Russell to Chief Operating Officer

(From Pg. 1)

"She has a deep understanding of every aspect of our industry and brings a unique perspective and human element to this important role. Her leadership will be instrumental in delivering a high-quality approach that will inspire us all to take fresh and creative steps to build on our strong foundation and serve the people we support in new and strategic ways."

Russell will lead the 45-year old organization's operational efforts and strengthen its value-based performance culture. She will address response and long-term management relating to the Covid-19 pandemic and the anticipated transition to managed care. She hopes to deepen and expand the community relationships that NHC currently holds, especially with local schools to enhance internships and volunteer opportunities. "I believe that we should always be learning and growing," said Russell, adding "As part of the community, we can share our resources and at the same time provide opportunities for local students."

She recalls that when she joined the staff at New Hope as a Service Coordinator in 1995, she only planned on staying for a year. However, the organization's commitment to its mission led her to stay. In her 25 years at New Hope, she has excelled in multiple roles, including Service Coordinator, Senior Service Coordinator, Director of Quality Assurance, Director of Corporate Compliance, Assistant Executive Director, and most recently, Senior Vice President of Clinical and Regulatory Operations. Russell will leverage this experience and in an executive capacity, she will oversee teams and initiatives that enable NHC to provide the highest quality holistic services and supports, ranging from innovative day programs to residential services. Working with senior management, she will oversee Human Resources, Health Services, Clinical Services, Quality Assurance and Compliance, and Residential Services. Additionally, she will be responsible for implementing a strategic five-year plan, collaborating with the executive leadership and Board of Directors to ensure fiscal sustainability and programmatic growth for the organization. Among the life-changing opportunities she sees for future enhancement are leading-edge research and technological advances, which hold great potential for improved communication and the goal of greater independence and choice for people who have disabilities.

"I value the experiences I have had at New Hope Community. I have built solid relationships and worked with people who valued my input and encouraged me to grow, and I try to provide the same support for all our staff and individuals. It's exciting to work alongside our Chief Executive Officer, Debbie McGinness, who is so accomplished in the field and has an exciting vision for the organization," Russell added.

Russell holds a Master of Jurisprudence in Health Care Law from Widener University School of Law and a Master's Degree in Social Work, Specializing in Gerontology, from Canyon College. She is a graduate of the National Leadership Consortium at University of Delaware, is certified in healthcare compliance (CHC) and is qualified as a Level One Certified Investigator. She earned her Bachelor's degree in Psychology from State University of New York at Oneonta.

An active community volunteer who believes in giving back to both assist and mentor others, for the past 10 years, she has been a member of the Sullivan County Chamber Foundation, serving as President/Chair and Vice President. She is a member of the Sullivan County Community Services Board and has been involved in other community service organizations.

She and her husband Harold have three daughters, Katie, Maggie and Regan and reside in Bethel, NY, where they enjoy their busy family life while staying active in their community.



First Class Formalwear

**Tuxedo's & Suits
Gown Alterations
Gown Preservation
Wedding Invitations**

Rentals & Sales

311 East Broadway • Monticello, NY 12701
(845) 796-1039
<http://www.firstclassformalwear.com>





Creating your own art is a form of meditation and a therapy unique to your own self. ***In the Spirit of Sumi-e***, written and illustrated by Linda G. Comando, is an easily understood explanation including simplified drawings that will lead you on a path of relaxation and will reveal your own potentiality and creativity.

Now available on Amazon:
Go to: <http://www.amazon.com>
then type *In the Spirit of Sumi-e*



to the point graphic design studio

... a full graphic design studio
offering branding, company logo design, brochures, business cards, stationery sets, website design and more...

Everything we do has a single unifying goal
Keep it simple – Go right
to.the.point
<http://www.tothepoint.50megs.com>
For information send an email to:
tvtownsman@yahoo.com
or call 845-985-0501

A Job Well Done

Roofs • Decks • Additions • Kitchen • Bathrooms
Interior & Exterior Painting and Staining
Flood Damage Repairs
Foundations • Beam • Sill Plates • Joists Repairs
Concrete Projects

845-428-4518 Free Estimates

IT CAN HAPPEN TO ANYONE

24/7 LOCAL ADDICTION INFO & REFERRAL

866-832-5575

**NATIONAL:
TEXT #HOPENY**



Denman Agency, Inc.

Insurance



P O Box 357
Grahamsville, NY 12740
Tel: 845-985-2284 ~ Fax: 845-985-2498

Interview with author: Dana Haynes

(From Pg 5) Reporters: We don't call it writers block; we call it unemployment.

So I can write a first draft of a 400-page novel in three months.

I also write first drafts in longhand, with a mechanical pencil and a steno pad. I write (creative brain) in the morning and transfer that writing to my computer (analytical brain) in the evening. If the scene's good, I can diagnose it that day. If it failed, I can diagnose that, too.

My daily writing goal is a complete scene.

How do you deal with a negative review?

Poorly.

have a terribly thin skin. I'm that guy who wakes up at 3 a.m. and remembers something dumb he did or said in the fifth grade. It's totally unhealthy, but there it is.

On the other hand, I love really, really stupid negative reviews. For "Crashers," a guy wrote to tell me I didn't understand the engineering of the downed airliner, a Vermeer 111. I wrote back that there is no such thing as a Vermeer 111; that I invented it. He wrote back and explained that, no, I got the details wrong.

Do you plot-outline or wing it?

A combination.

I'm a former theater guy, so I write in the three-act structure, with plot points that kick the story into Act II and into Act III. Generally, when I start a new series, I know the protagonists, the antagonists, and the basic story . . . to a point. I also have a pretty good idea of the plot points. What I don't know is how the story will end.

Example: "Sirocco," the book that came out in January 2021. I knew that Act I would establish a mad bomber who'd made fools of U.S. and European intelligence agencies, and that a macho, American private military contractor would be strutting around, mucking up things for my protagonists, Michael Finnigan and Katalin Fiero. And I knew that the B story would swerve from trying to stop the bomber, to trying to save Fiero's own family (contrary to popular belief, it's good to ratchet down the goals in a thriller: Go from trying to save some amorphous "them" to trying to save a very specific "him.")

But how it would end? That I didn't know until I got there.

What method do you use to keep track of plot details?

Every 10 pages or so, I go back and read the last 20. That is: When I hit page 130, I go back and read 110 to 130. I write 10 more, go back 20 (120 to 140). This lets me focus on a small, truncated coda of the story. (Did I get those scenes right?) Then, every 100 pages, I stop, print it out, wait a week or two, and read the whole manuscript. This lets me see the story from the 30,000-foot level. (Am I getting this story right?)

What type of scene is most difficult for you to write?

Sex scenes. My mom reads my books. I cannot afford that much therapy.

INSPIRATIONAL THOUGHT

Don't write what's "hot," write a book that you'd pay money to read. You are your own first audience. If you don't love the story, it's unlikely any other reader will, either. If you do a great job entertaining yourself, you're more likely to have a publishable novel on your hands.

Thanks Dana, it's been an absolute pleasure! And please keep us up-to-date on your next St. Nicholas Salvage & Wrecking yarn.

BIO

Dana Haynes is the author of nine published mysteries and thrillers from Bantam Books, St. Martin's Press and Blackstone Publishing. His first short story appeared in the 2019 anthology for the Bouchercon World Mystery Convention, and the second will hit the stands in 2021 in Alfred Hitchcock Mystery Magazine. He is an award-winning newspaper journalist and former political speechwriter. His latest series kicked off in 2019 with "St. Nicholas Salvage and Wrecking." It was followed in January 2021 with the sequel, "Sirocco." Dana lives in Portland, Oregon, with his wife, Katy King, and their cat, Violet. For more information: danahaynesmystery.com

Fallsburg Jr. Sr. High School First Quarter Superintendent and Honor Roll Recipients 2020/2021

12th Grade Superintendent Honor Roll

Ava Anderman, Madelin Moran, Gabrielle Pantel, Jamie Rein, Mindy Asitimbay, Madison Lent, Gianna Matthews, Dolce McPherson, Kailie Ruiz, Ennie Li, Jaiden Brenner, Fatoumatta Darboe, Emily Mead, Bianca Cruceta, Siomarelix Ocasio-Ortiz, Lindita Ahmetaj, Angelina Colletti, Cody Harvey, Om Patel, and Velkys Canales Mendoza.

12th Grade Honor Roll

Gabiella Aragon, Areli Diaz, Thomas Doolittle Jr., Essence Jackson, Noah Moody, Areli Perez Grande, Janelly Santos Lopez, Neema Darboe, Enelay George, Amy Manjarrez, Isaiah Mathews, Karen Magaly Melara Reyes, Daniel Milov, Genesis Nallely Osorio Gutierrez, Arne Peterson-Langeland, Nevaeh Valree, Alexandra Gonzalez Caballero, Dicziana Campos Fuentes, Nicholas Fraser, Haddy Gai, Crystal Pinder, Tayshawn Cannonier, Tamia Caston, Mark Rodriguez Tellez, Elmin Granados Gomez, Christian Granados Sandoval, and Madison Shene.

11th Grade Superintendent Honor Roll

Kaitlyn Cross, Jonathan Espinoza, Carol Carbajal, Emily Collura, Santiago Cordero Jr., Musa Dumbuya, Angie Delgado, Anna Dell'Aquila, Josie Galeas Iraheta, Yahaira Garcia, Emily Hannold, Daphne Hernandez Calderon, Jonathan Hernandez, Audrey Nicolai, Estefani Rodriguez, Jonathan Rodriguez, Nabihah Shah Jahan, and Kyle Tremper.

11th Grade Honor Roll

Tahjane Coakley, Olga Flores Bonilla, Helen Flores Mayrena, Ashley Grande, Robert Heyward III, Ceci Mancia, Marlo Matinez Rivas, Oliver Normington, Katerin Pena Ortiz, Samiya Ramos, JonCarlos Reyes, Alexandra Rodriguez, Thalia Sandoval, and Jennifer Santos,

10th Grade Superintendent Honor Roll

Leona Ahmetaj, Hunter Doty, Isabella Frunzi, Carla Granados, Jason Hernandez, Jasmine Jackson, Najuwa Ladan, Samantha Medina Garzon, Nicholas Muscia, Michael Razumoski, Andrew Rein Jr., Maritza Rivas Joya, Iyanna Smith, and Christos Vernezos. (Contd. Pg. 14)

Fallsburg Jr. Sr. High School First Quarter Superintendent and Honor Roll Recipients 2020/2021

(From Pd. 13)

10th Grade Honor Roll

Brian Aragon, Sean Black, Kayalah Brewster, Bintou Darboe, Gisella King, Stephanie Granados, Adrian Jimenez Castillo, Caleigh McDole, Edwin Morales Jr., Katerin Nunez, Dayanara Olan, Allison Perna, Gage Pittaluga, Cyriah Russell, Mateo Scanna, Michael Storms, Yadhier Tejada, Allie Wiener and Josephine Zyla.

9th Grade Superintendent Honor Roll

Ezekiel Acosta, Gustavo Avila Morales, Jordan Batista, Nikolas Bonner, Angeleena Bruno, Lila Dedrick, Emma DeGraw, Alaina Dinkel, Jaedon Espinoza, Keiry Guzman-Aguirre, Mia Irlbacher, Angelina Levner, Adam Mednick, Emily Perna, Jalysa Poindexter, Nadiushka Rosa Gonzalez, Rugiatu Sesay, Salih Sinanaj, Laila Varlee and Isaiah Young.

9th Grade Honor Roll

Meredith Anderman, Haris Basic, Jonah Batres, Dominick Bush, Zorah Cannonier, Alexander Depuy-McBride, Sherlin Bruno, Eduardo Escoto Morales, Arianna Gonzalez, Marjorie Hernandez, Kristian Huttemeyer, Jacob Lawrence, Steve Lundy-Sarnowski, Danica Morris, Cecelia Norris-Yanes, Georgia'Rane O'Brien, Catherine Pena, Juliza Pineda, Elizabeth Rivas-Ferrufino, Cindy Romero, Besart Selimaj, Abigale Smith, Alyssa Ticali.

8th Grade Superintendent Honor Roll

Maya Ballard, Isabelle Batista, Arslyn Cantave, Evyonna Gilliard, Hayden-Marie Herrera, Nicole Jimenez, Hannah Johnson, Erli Alessandro Maldonado, Nancy Martinez Cadena, William Martinez, Rachel Montenegro, Bella Muscia, Vivian Ordonez Cabrera, Dalila Ortiz Fuentes, Keyla Otero-Deras, Kaitlyn Pedersen, Byron Pratt, Cecelia Riker Lainez, Ioannis Vernezos and Jordyn Wall-Carty.

8th Grade Honor Roll

Rubin Bonilla Jr., Ethan Dunn, Kenya Escalante, Luciano Esposito, Kaelyn Fuentes, Isaac Hernandez Martinez, Prissila Hernández Palacios, Daris Koljenovic, Mayline Maldonado, Francely Maradiaga, Brianna McManus, Jennifer Murillo, Kayla Peace, Jennifer Rios Nunez, Yessenia Rodriguez, Jaily Sebastian, Nicholas Storms, Elisheva Sudranski, and Gabriella White.

7th Grade Superintendent Honor Roll

Angelina Alvarado, Diego Balcazar Lavin, Saladin Basic, Robert Berman, Xzavier Berrios, Allison Cabrera, Jaecob Espinoza, Brian Ingber III, Jaxon Ingber, Johnarris Lopez-Landaverde, Douglas Medina Carcammo Jr., Jansel Rosa Gonzalez, Steve Snihura, Kierstyn Surerus, Noelle Varner, and Nataly Zempoaltecaltl.

7th Grade Honor Roll

Alexia Clark, Bintou Darboe, Olivia DeGraw, Isaac Delgado, Isabella Giannico, Angel Gonzales, Eric Li, Jadiel Monche, Joslyn Odell Schreier, Austin Olmsted, Allanah Owens, Madeline Pantel, Allison Rojas, and Gavin Storms.

DEC Releases Proposed Regulation to Prohibit Pesticides Containing Chlorpyrifos

Banning Pesticides That Contain Chlorpyrifos Fulfills Governor Cuomo's Directive, Protects New Yorkers from Potential Health Impacts, and Safeguards Environment and Pollinators

New York State Department of Environmental Conservation (DEC) Commissioner Basil Seggos today announced the release of a proposed regulation to prohibit the sale, distribution, possession, and use of pesticide products containing the active ingredient chlorpyrifos. Governor Andrew M. Cuomo directed DEC to ban chlorpyrifos, an organophosphate pesticide, in December 2019 to safeguard public health and protect environmental resources, particularly pollinators. The proposed regulation is in today's State Register and DEC is accepting public comments on the proposal from Jan. 27 through April 5, 2021.

Commissioner Seggos said, "Directed by Governor Cuomo, New York is at the forefront of environmental leadership and among the first states in the nation to ban pesticides containing chlorpyrifos. The release of the proposed regulation today is further evidence of New York's sustained commitment to protecting our communities and the environment and I encourage interested New Yorkers to review and comment on the proposal."

This proposed regulation will add chlorpyrifos to the list of prohibited pesticides in 6 NYCRR 326.2(c) of New York's pesticide registration regulations. Scientific research has shown that chlorpyrifos can harm the development of the nervous systems of infants and young children. Prenatal exposure to organophosphates can result in diminished cognitive ability, delays in motor development, and Attention Deficit/Hyperactivity Disorder (ADHD).

Information concerning the review process, proposed rulemaking, and supporting documents can be accessed from DEC's website or at DEC, 625 Broadway, Albany, NY 12233. To review the documents at DEC's Central Office, call Melissa Treers for an appointment at (518) 402-8678 or email Melissa.Treers@dec.ny.gov. To submit written comments via email, write to chlorpyrifosregs@dec.ny.gov with "Comments on Proposed Part 326" in the subject line of the email. Comments submitted by mail should be sent to DEC's Pesticide Enforcement & Compliance Assurance Section, NYSDEC, Division of Materials Management, 625 Broadway, Albany, NY 12233-7254. DEC is accepting public comments on the proposed regulation through April 5, 2021.

The application of pesticides must be done in a manner that is protective of public health and the environment and New York State's pesticide regulatory program is a national leader in the review and registration of pesticides, implementation of regulatory controls, and the enforcement of the worker protection standard. State law affords DEC with a broad range of regulatory powers including the ability to restrict the use of a pesticide and revoke pesticide registrations.

To complement this regulation, DEC cancelled the registration of 29 pesticides containing chlorpyrifos on Dec. 31, 2020, and is cancelling the registration of the remaining 15 pesticides as of July 31, 2021. Following cancellation, a pesticide can no longer be sold, distributed, or used in New York State. In addition, these canceled pesticides cannot be stored after the manufacturer's container has been opened. DEC recommends the public to check the New York State pesticide registration status of these products on the New York State Pesticide Administration Database. If the pesticide is not currently registered in New York State, consult with pesticide distributors or the manufacturer to determine the appropriate options for removal or disposal of the pesticide.

In addition, DEC is holding a virtual public comment hearing for the proposed rule at 6 p.m. on March 30. The electronic webinar format is reasonably accessible to persons with impaired mobility. Instructions on how to join the hearing, how to provide an oral statement, and how to register are available at DEC's website. Contact DEC at (518) 402-9003 with any additional questions regarding the virtual hearing.

Super Bowl Sunday 2021 - L. Comando

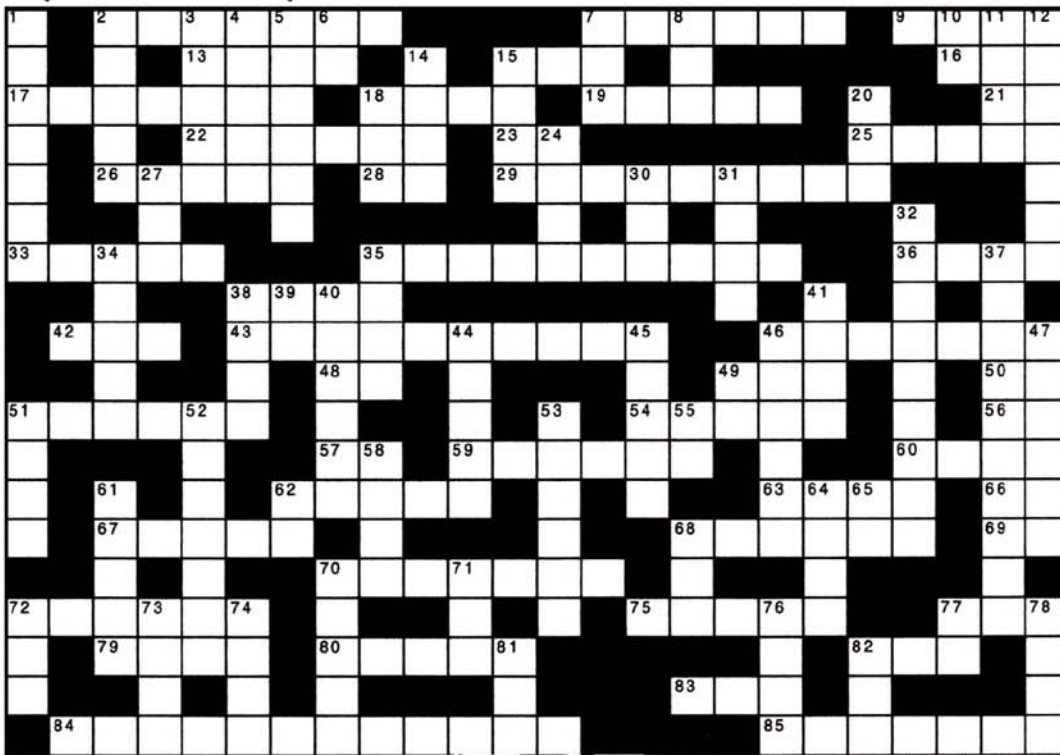

ACROSS

- 2 A football
- 7 Place or state of supreme bliss
- 9 Social winged insect
- 13 Sour
- 15 Missing in Action
- 16 Hot drink
- 17 Player positioned on the line of scrimmage
- 18 Judd Hirsch starred in this TV series
- 19 Means of communication
- 21 ---, --- Eliot, Literary Modernist
- 22 Endows great quality
- 23 Term for natural killer cells

- 25 Emblem of Christianity
- 26 Savor
- 28 New York
- 29 Complex " " Bowl Sunday
- 35 Following a logical order
- 36 Pleasant
- 38 Bishop of Rome
- 42 Sweet potato
- 43 Logical
- 46 Planet closest to the sun
- 48 Sforzando (musical)
- 49 Fastener
- 50 Common Era
- 51 Bunch
- 54 Sightless
- 56 United States
- 57 Exclamation of surprise
- 59 Geld
- 60 Ensemble

- 62 Fracture
- 63 Famous female blues singer
- 66 Chemical element
- Tellurium
- 67 Roman statesman and scholar (23-79)
- 68 Ceremony
- 69 Either
- 70 Shine brightly
- 72 Coiled
- 75 Distort
- 77 Eastern Standard Time
- 79 Old king in nursery rhymes
- 80 Defensive action to tackle a quarterback
- 82 Low steady continuous sound
- 83 Curve
- 84 Act of a defensive player catching a forward pass
- 85 Spicy tomato condiment

DOWN

- 1 Protective head coverings
- 2 Several varieties of wine grapes
- 3 Forms of play
- 4 Minimal
- 5 Having a friendly nature
- 6 Part of the human psyche
- 7 Meat from a pig
- 8 Affix
- 10 Expressing a location
- 11 Stands something
- 12 Pliant; obedient
- 14 Not hard
- 15 Small version
- 18 Decade
- 20 Higher than a King
- 24 Part of the human leg
- 27 Large primate
- 30 Ritenuto (music)
- 31 Zodiacal sign for Cancer
- 32 Relating to a closed curve that is drawn in on a single movement

- 34 Plastic yarn
- 35 Persona
- 37 Longer than the most direct way
- 38 Stride
- 39 Being worn by a person
- 40 Clergyman
- 41 Shape into a curve
- 44 Reason
- 45 Tag
- 46 A stately ballroom dance
- 47 Poetic or archaic form of yesterday
- 49 Used in the formula to measure the circumference of a circle
- 51 Crazy person
- 52 Left-brained
- 53 When the offensive player loses the ball
- 55 Symbol for radioactive metal
- 58 Assist
- 61 Relating to the visual
- 62 Near
- 64 Strong desire

- 65 Innovative US city
- 68 Running in a straight line
- 70 Short-tailed marten
- 71 Furrow
- 72 Ocean
- 73 Tuber
- 74 Legendary Shakespearean king
- 76 Large bag
- 77 Printer's measure
- 78 Stumble
- 81 Menagerie
- 82 Small crude shelter

Buffalo Chicken Wings

- Oil for deep frying
- 1/4 cup butter
- 1/4 cup hot sauce
- 1 dash ground black pepper
- 1 dash garlic powder
- 1/2 cup all-purpose flour
- 1/4 teaspoon paprika
- 1/4 teaspoon cayenne pepper
- 1/4 teaspoon salt
- 10 chicken wings

Heat oil in a deep fryer to 375 degrees F (190 degrees C). The oil should be just enough to cover wings entirely, an inch or so deep. Combine the butter, hot sauce, pepper and garlic powder in a small saucepan over low heat. Stir together and heat until butter is melted and mixture is well blended. Remove from heat and reserve for serving.

In a small bowl mix together the flour, paprika, cayenne pepper and salt. Place chicken wings in a large nonporous glass dish or bowl and sprinkle flour mixture over them until they are evenly coated. Cover dish or bowl and refrigerate for 60 to 90 minutes.

Fry coated wings in hot oil for 10 to 15 minutes, or until parts of wings begin to turn brown. Remove from heat, place wings in serving bowl, add hot sauce mixture and stir together. Serve.

数字は単数に限る

9		3	2			4	6
4	6				7	5	
				4	6		3
	9	4					1
		1		6		4	
6						3	9
5			6	7			
	7		4			1	5
3	4				5	2	8

SUPERBOWL CRYPTOGRAM

A	B	C	D	E	F	G	H	I	J	K	L	M	N	O	P	Q	R	S	T	U	V	W	X	Y	Z
---	---	---	---	---	---	---	---	---	---	---	---	---	---	---	---	---	---	---	---	---	---	---	---	---	---

13 15 15 11 18 22 14 14 1 9 22 2 1 2 3 16 12 21 1 18 14 **

19 22 24 12 9 15 24 12 11 1 24 12 9 1 11 9 9 15

1 2 3 16 12 21 1 18 14 12 1 11 9

26 2 18 12 14 1 12 10 22 18 14 12



- Tom Landry

The game is underway.
What are the differences between the two pictures?

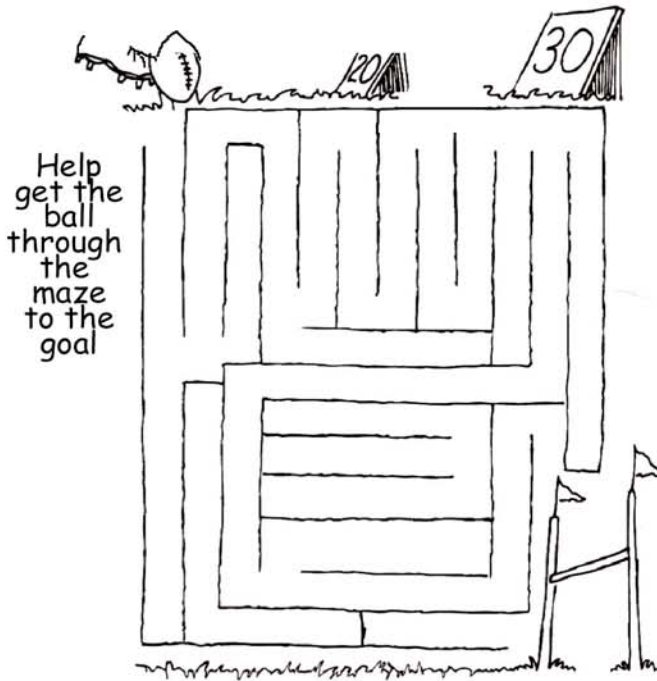

Help get the ball through the maze to the goal

Kids' Super Bowl Sunday Fun Page

Follow the dots to see an important piece of football equipment

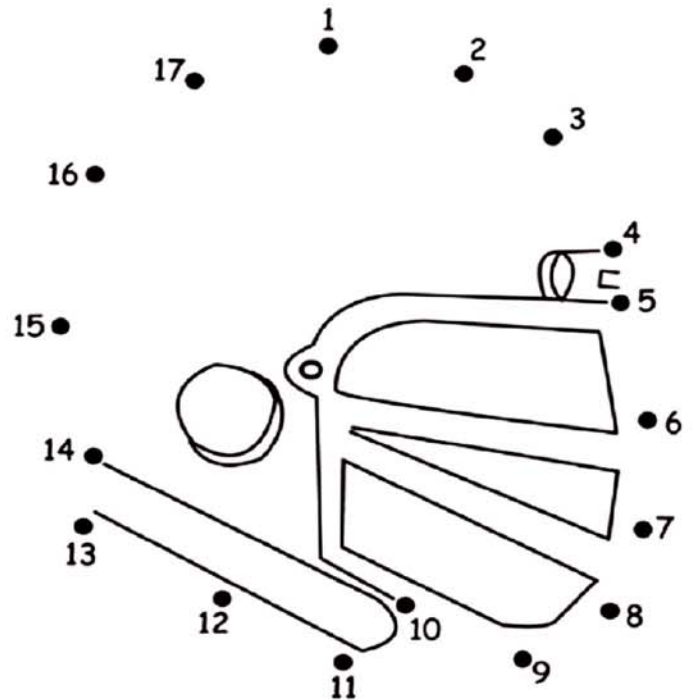

WORDSEARCH

M D F E E M B A H L D S
 Z U K U K B H B U B H G
 N W O G M I R P D L H K
 C W J K M B H T D O C X
 F O O T B A L L L C A W
 Q B K D L F E E E K O M
 U C R L J F S S Z Y C E
 E E P A J O N K E Z P O
 V F T O G K E V N T U R
 I N P G K C F G X I Y X
 R A Z C V I E X Z L I Y
 D K T C Y K D R B B H I

FOOTBALL
 DEFENSE
 BLITZ
 BLOCK
 DOWN
 DRIVE
 COACH
 GOAL
 FUMBLE
 HIKE
 HUDDLE
 KICKOFF

Cryptogram Key

8	22	18	3	21	12	13	19	5	1	20	7	14	24	2	15	4	6	16	9	11	26	10	17	25	23
Z	A	B	C	D	E	F	G	H	I	J	K	L	M	N	O	P	Q	R	S	T	U	V	W	X	Y

Daniel Pierce Library

The library is open for browsing, computer use, and more.

Curbside pickup is still available by appointment!

Visit the Library!

You can browse for books and movies or use the internet on one of our computers.

Computer use is limited to 30 minute sessions.

Curbside Pick Up

Call to make an appointment!

Monday
10:00 - 1:00

Tuesday & Thursday
10:00 - 6:00

Wednesday & Friday
10:00 - 4:30

Lobby Hours

Monday
11:00 - 1:00

Tuesday - Friday
11:00 - 4:00

LEGALS/PUBLIC NOTICES

**TOWN OF NEVERSINK
PLANNING BOARD
P.O. BOX 307 - 273 MAIN STREET
GRAHAMSVILLE, N.Y. 12740
(845) 985-2262**

PUBLIC NOTICE

Please take notice that the Town of Neversink Planning Board will hold a public hearing, pursuant to Section 267, Town Law, on the application of FSH Lodge at Neversink, LLC for the purpose of a Site Plan Review for a Health Spa Located at 7491 State Rte. 55 Neversink NY, (SBL# 30.-1-39.1).

Said hearing will take place at the Neversink Town Hall, Grahamsville, NY on Wednesday, February 3, 2021 at 7:00 P.M. at which time all interested parties will be given an opportunity to be heard.

PLEASE NOTE: Due the potential for a large public interest in this application and the lack of space in our conference room for proper social distancing rules we will be offering a ZOOM meeting and asking that the public attend the meeting via this service. Please use the following information for logging in to the meeting:

Join Zoom Meeting

<https://us02web.zoom.us/j/88469443456?pwd=NjEybRydIVzbUdrbmNneE9hNGlMdz09>

Meeting ID: 884 6944 3456

Passcode: 240323

Dial by your location

+1 646 558 8656 US (New York)

Meeting ID: 884 6944 3456

Passcode: 240323

BY ORDER OF PLANNING BOARD
TOWN OF NEVERSINK
PHILIP COOMBE III, CHAIRMAN

**Applications Sought for
UCRRA Board Seat**

Kingston, NY - Calling all those interested in promoting sustainable materials management practices in Ulster County by efficiently managing solid waste materials with a focus on resource conservation; Now is the time to apply for a seat on the Ulster County Resource Recovery Agency (UCRRA) Board if you are interested in serving your community.

(Contd. Pg. 19)

**Tri-Valley CSD
Board Meeting**

Thursday, February 4, 2021

Anticipated Executive Session 6:00 p.m.

Regular Meeting #16 7:00 p.m.

This meeting will be on YouTube Live

<https://www.youtube.com/channel/UCkl224vKQ8nAWhR6NVao24w/live>

ROURKELAW.COM

845.292.2000



ROURKE LAW

*Your Trusted
Counsel in the
Catskills*



25 Darbee Lane, Liberty



**REAL ESTATE • CIVIL • FAMILY • DWI
ESTATES & TRUSTS • INJURY & MORE**

Applications Sought for UCRRA Board Seat

(From Pg. 18) The UCRRA is a public benefit corporation formed for the purpose of developing, financing, and implementing a comprehensive county wide materials management program. The UCRRA manages solid waste and is responsible for compliance with State and Federal laws, rules and regulations regarding the management and long-term obligations of closed solid waste management facilities and currently operating facilities under its direct control.

The Agency's responsibilities also include education and public outreach efforts to encourage, support, and foster participation by the public with respect to reducing, reusing, recycling and composting portions of the existing solid waste stream.

The County's solid waste system has reacted to a variety of market changes, regulations and shifting social demands for responsible programs that go beyond recycling. Legislators and other community leaders feel that due to the global climate crisis Ulster County needs to reduce and divert as much waste as possible. Exciting plans to approach zero waste are being developed and the UCRRA, County Departments and other groups will need to work together to reach these goals.

Anyone interested in being considered should email a resume and/or explanation of why you would be an asset to the UCRRA Board no later than February 8th to the Clerk for the Energy and Environment Committee, Fawn Tantillo, at ftan@co.ulster.ny.us.

"Welcome to a new world"

5 Wednesday sessions to face the challenges of 2021

Join your Sullivan County Chamber of Commerce for a series of five Wednesday mornings in February and March to learn and talk about a variety of topics that can make 2021 a successful year for your business.

These will be 1-hour, 8 AM virtual and interactive panel sessions with a moderator and subject experts. Bring your coffee or tea and join us for one or all of the following sessions:
SESSION 1: COVID related business and relief programs: What's out there and who can apply?

Date: February 10, 2021

Time: 8:00 AM - 9:00 AM EST Register For Session 1 HERE: <https://business.catskills.com/events/details/welcome-to-a-new-world-virtual-winter-wednesdays-session-1-9712>

February 10, 2021: COVID related business and relief programs: What's out there and who can apply?

February 17, 2021: Health & Safety: How to keep customers, your staff, and yourself safe & protected.

February 24, 2021: The Chamber's collaboration with Lunarcow: How to get the most benefits out of the Chamber's digital platform.

March 3, 2021: Marketing for 2021: What's different, what's new, what works, and what doesn't?

March 10, 2021: Fit for survival: staying healthy, focused & sane!

All sessions are free and run from 8-9 AM. The Sullivan County Chamber uses the gotomeeting platform. Sign-on links will be released on Chamber website and social media prior to each session.

Suicide Prevention Training QPR Question. Persuade. Refer.

Sullivan County currently has the highest suicide mortality rate in the Hudson Valley. Through this free 90 minute training



"It's Good to Know an old Country Lawyer!"

William A. Brenner ESQ.

Attorney-At-Law

**157 Main Street, (Route 55 at Route 42) P.O. Box 369
Grahamsville, NY 12740**

Very Important

Have you made a "Simple Will"?

- 1) Spouse with children or
- 2) Couples living together
- 3) Second marriages

[must personally meet and discuss your ideas, plans & options]

Real Estate

Purchasers & Sellers

"UPDATED DEEDS"

Legal Questions?

Free Consultation

NOTARY • FAX • PHOTOCOPIES

Call Immediately to discuss what to do

845-985-7411

Email: williambrenner@hotmail.com • Fax: 845.985.0274 • NYC call Toll Free: 877.638.6011

you can become a QPR Gatekeeper trained to recognize the warning signs of suicide. Sessions offered: February 15, March 15, April 19 & May 17

For more information: <https://sullivan180.org/portfolio-items/qpr-suicide-prevention-training/?portfolioCats=68>

The 43rd Annual 98.3 WSUL Heart-A-Thon Friday, February 19, 2021 "The Beat Goes On"

Hearts are available at the Chamber and other sites around the county. More info at: www.wsul.com

RENAISSANCE GRANT WORKSHOP

Learn About Grants, Volunteer Opportunities, Summer Employment, and Scholarships
Wednesday, February 3, 2021 6:00 PM - Online

Do you have an idea for a project for your community? Is there a spot in your town that could use some sprucing? Are you interested in volunteer and internship opportunities? Sullivan Renaissance will hold a grant workshop on Wednesday, February 3, 2021, at 6 pm via Zoom to explore this and so much more. Community organizations, churches, schools, and businesses interested in beautifying their community are invited to attend, learn about grant resources and meet with individual program staff.

Sullivan Renaissance offers a variety of grants to support building beautiful, active communities in Sullivan County, New York. Grants range from mini grants for beginning efforts to community beautification, with gardens, hanging baskets, and planters, and more involved community-wide work, such as parks and multiple garden sites. Other grant categories include business assistance, technical assistance, healthy community initiatives, and neighborhood revitalization. Attendees will be able to speak with Sullivan Renaissance staff to determine what support best suits their project idea.

Other areas to be covered include scholarships, internships for youth between the ages of 16 and 20, volunteer outreach, and successful marketing for your community project.

Pre-registration for this free event is required at SullivanRenaissance.org or https://zoom.us/webinar/register/WN_w09YOkqDT0mjxkuQaQnzdQ by calling the office at or call 845-295-2445. Event details can also be found on the Sullivan Renaissance Facebook page.

If you wish to download this week's Church bulletin from St. Peter's, Liberty, NY please go to: stpeters/bulletin

As New York begins to open allowing churches to once have services, we encourage our readers to contact their individual church or parish for updated information.

St. Mark's UM Church
68 Clinton St., Napanoch

**YARD AND CLOTHING SALE
CLOSED
UNTIL FURTHER NOTICE**



Sundown United Methodist Church

Covered Dish Supper

5:30 pm

To be Announced

Sundown United Methodist Church Hall



Grahamsville United Methodist Church

Saturday Thrift Sale

9:00 am to 12 noon
To be Announced

Thrift Sale
9am-12 noon
Luncheon
11 am - 12:30 pm
To be Announced



COLONIAL FAMILY of FUNERAL HOMES

**PRE-PLANNING, FUNERAL & CREMATION SERVICES
VETERAN'S CARE, MONUMENTS & ENGRAVING**

LOCATIONS IN WOODBOURNE, LIBERTY, MONTICELLO, LIVINGSTON MANOR & KAUNEONGA LAKE

434-7363 292-7160 794-2700 583-5445 439-4333

<http://www.colonialfamilyfuneralhomes.com>

MONUMENTS INSTALLED IN ALL CEMETERIES
CREMATION MEMORIALS & BENCHES, MONUMENT LETTERING & CLEANING



ST. ANDREW'S EPISCOPAL MISSION

The Little Church with the Big Heart

Sunday, 8 am Service of Holy Communion, except: Second Saturday of each month, 12:00 noon

Music by Fred VanWagner
Coffee hour follows service
All are welcome!

5277 State Rt. 42 • South Fallsburg
845-436-7539
www.standrewsepiscopalmission.org

CATHOLIC PARISH OF THE IMMACULATE CONCEPTION
(Embraces Fallsburg, Neversink, Sundown and Ulster Heights)

6317 Rte. 42, Woodbourne, NY

Weekend Mass schedule:
Saturday afternoon: 4:30 pm
Sunday morning: 9:00 am and 11:30 am

Daily Mass Schedule: Monday morning 8:50 am; Tuesday morning 8:50 am; Wednesday morning No Mass; Thursday afternoon 5:45 pm; Friday morning 8:50 am and Saturday morning 8:50 am.

Saturday afternoon confessions: 3:45 to 4:15 pm
Rev. Ignas Dhas MMI, Administrator
(845) 434-7643



Sundown United Methodist Church
Peakamoose Rd., Sundown
Sunday Worship Service - 8:30 a.m.
Wednesday Bible Study - 6:45 p.m.
Pastor Seung Jin Hong
845-985-2283
e-mail: Sundownumc@gmail.com

Grahamsville United Methodist Church
Rte. 55, Grahamsville
Sunday Worship Service - 10:30 a.m.
Sunday School for grades k-7 - 10:30 a.m.
Mid-week Bible Study opportunities available!

Regular Office Hours
Wednesday 9 am - Noon
Friday 3 pm to 6 pm

If you wish to make an appointment to talk to Pastor Seung Jin Hong please call 845-985-2283

For all other information contact Pastor Seung Jin Hong.
845-985-2283 • e-mail: Grahamsvilleumc@gmail.com

Grahamsville Reformed Church

The Church with a friendly welcome

Pastor Kenneth Ronk
Sunday School 9:30 am
Worship Service 9:30 am
P O Box 238 - Route 55
Grahamsville, NY 12740
845-985-7480

Claryville Reformed Church



Claryville Road
Claryville, NY 12725
845-985-2041

Worship Services @ 10:00 am

Church Hall available for rent
Call - 845-985-2041 for information

St. Augustine's Chapel
Watson Hollow Rd. • West Shokan, NY

Sunday Mass - 9:30 am
Holy Days 5:30 pm

Penance 9:00 am, 2nd Sunday of the month
Rev. Thomas P. Kiely, **Pastor**

Loucks Funeral Home

Geoff and Heather Hazzard

"Celebrating Life, One Family at a Time"

79 North Main Street
Ellenville, New York
(845) 647-4343

AL-ANON MEETINGS- <http://www.al-anon.alateen.org>
 Mon- 7:00 p.m. United Methodist Church, 170 N. Main Street, Liberty • Thurs- 7:00 p.m. Immaculate Conception Church Annex, 6317 Rt 42, Woodbourne
 Sat- 8:00 p.m. United Methodist Church, 170 N. Main Street, Liberty

VETERANS always **Free** search of the Archives for family or history of Sullivan County at the **Sullivan County Museum**, 265 Main St., Hurleyville, NY. For information call 845-434-8044.

Ans to last week's Crossword

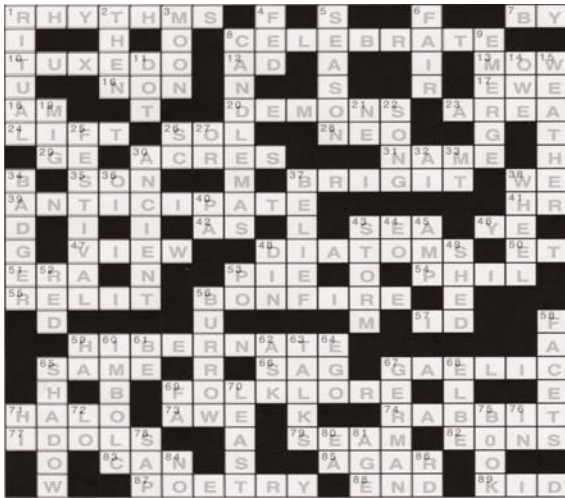

Tips for Winter Hiking: Plan, Prepare, Explore

Have fun, stay fit, and be safe on the trails this winter! In this recorded webinar taught by the Trail Conference's Director of Donor Advising, you'll get advice on trip planning, winter gear, packing and dressing for safety and comfort, dealing with winter trail conditions, and leading a successful outing. Don has led more than 600 hikes and trail runs for the Trail Conference, West Milford 13ers Hiking Group, Trail Conference Trail Runs, and other groups. Go to: <https://www.facebook.com/groups/1902015199943961>

PRAYER TO THE BLESSED VIRGIN (Never known to fail)

Oh most beautiful flower of Mt. Carmel, fruitful vine splendor of Heaven, Blessed Mother of the Son of God, Immaculate Virgin, assist me in my necessity. Oh Star of the Sea, help me and show me herein you are my Mother. Oh Holy Mary, Mother of God, Queen of Heaven and Earth I humbly beseech you from the bottom of my heart to succor me in this necessity. (Make request)

There are none that can withstand your power. Oh show me herein you are my Mother. Oh Mary conceived without sin, pray for us who have recourse to thee. (3x).

Holy Mary I place this cause in your hands. (3x).

Say this prayer for 3 consecutive days. You must publish it, and it will be granted to you.

OEA

Time in the Valleys Museum presents:

Glaciers of the Catskills

February 21 @ 2:00 pm - 3:00 pm EST

Sunday February 21 2 p.m.

Virtual Program • Cost: FREE

Join Haley Springston Watershed Coordinator of the Rondout-Neversink Stream Management Program for an illuminating program on Catskill Glaciers. To attend this virtual event, email the Museum at info@timeandthevalleymuseum.org to register, and you will receive a reply email invitation with information on how to log in to Zoom.us for the talk. Please call 845-985-7700 or info@timeandthevalleymuseum.org for more information.

Tannery Hides and the Beaverkill Bridge

February 28 @ 2:00 pm - 3:00 pm EST

Sunday, February 28, 2 p.m.

Virtual Program • Cost: FREE

Town of Rockland Historian Joyce Conroy will tell the story of how 100 year old tanned hides were found in the Beaverkill Bridge. To attend this virtual event, email the Museum at info@timeandthevalleymuseum.org to register, and you will receive a reply email invitation with information on how to log in to Zoom.us for the talk. Please call 845-985-7700 or info@timeandthevalleymuseum.org for more information.

Spring into Seeding

March 7 @ 2:00 pm - 3:00 pm EST

Sunday, March 7, 2 p.m.

Virtual Program • Cost: FREE

John W. Story of Story's Neversink Plant Co. In Neversink, NY will demonstrate how to start vegetable seeds and how to make cuttings of common flowering garden plants. Using step by step instructions each step will be demonstrated and explained so you will be able to easily do it for yourself and have a successful garden this spring. Question and Answer session will follow.

To attend this virtual event, email the Museum at info@timeandthevalleymuseum.org to register, and you will receive a reply email invitation with information on how to log in to Zoom.us for the talk. Please call 845-985-7700 or info@timeandthevalleymuseum.org for more information.

SUUJI WA TANSU NI KAGIRU
 answer

9	8	3	2	5	1	7	4	6
4	6	2	3	8	7	1	5	9
1	5	7	9	4	6	8	2	3
8	9	4	7	2	3	5	6	1
7	3	1	5	6	9	4	8	2
6	2	5	8	1	4	3	9	7
5	1	8	6	7	2	9	3	4
2	7	9	4	3	8	6	1	5
3	4	6	1	9	5	2	7	8

ARTISTS • CRAFTERS
 Need a website?
 Call us at 845-985-0501
 email: tvtownsman@yahoo.com
 or visit our Virtual Mall
gnomehome.net

DEC Proposes Regulations to Improve Food Scrap Recycling and Prevent Food Waste

New Regulations Would Help Prevent Landfilling Food Scraps that Contribute to Climate Change and Connect More Hungry New Yorkers with Edible Food – Virtual Public Hearings on April 7; Public Comments Accepted until April 27

New York State Department of Environmental Conservation (DEC) Commissioner Basil Seggos today announced proposed regulations to implement a new statewide waste reduction initiative that supports food donation to help hungry New Yorkers and food recycling to help prevent the landfilling of food scraps. The proposed regulations would require composting and the donation of edible food by large food scrap generators to promote an effective reuse of materials otherwise headed for landfills. DEC will hold two virtual public hearings on the draft regulations on April 7, and is accepting public comments on the proposal until April 27.

"Reducing food waste has significant environmental benefits, including creating useful compost and decreasing the amount of materials that would otherwise be sent to a landfill, eventually creating methane gas that contributes to climate change," Commissioner Seggos said. "Perhaps even more critical now, when so many New York families are struggling with food insecurity during the pandemic, these proposed regulations support initiatives to connect hungry people with edible food and support organizations like Feeding New York State that are working to reduce hunger in our communities."

The draft regulations would implement the Food Donation and Food Scraps Recycling Act, which goes into effect in January 2022. The regulations implement the Act's requirements for all designated food scrap generators to donate excess edible food and send food scraps to an organics recycler if one is available within 25 miles of the generator. The increase in food donation will help New Yorkers in need and result in job creation to assist the not-for-profits that handle food donations. The act also requires generators to recycle food scraps by using organics recyclers (composting facilities, etc.) to reduce the amount of food scraps that would otherwise end up in landfills and ultimately produce methane, a potent greenhouse gas. Composting facilities and other organics recyclers produce beneficial organics soil conditioners that are needed to improve the quality of poor soils and reduce erosion.

DEC's draft regulations define a food scrap generator as an entity that generates an annual average of two tons of food scraps or more per week at a single location. These entities include, but are not limited to, supermarkets, food service businesses such as restaurants, higher education institutions, hotels, food processors, correctional facilities, and sports or entertainment venues. The proposal exempts New York City, hospitals, nursing homes, adult care facilities, and elementary and secondary schools.

The draft regulations also detail requirements to donate excess food and recycle food scraps if an organics facility is available, as well as annual reporting. In addition, the proposal includes a temporary waiver provision for generators that demonstrate a need to be excluded from certain requirements, such as a lack of food scraps transporters nearby. The proposal also outlines requirements that apply to transporters, transfer facilities, landfills, and combustion facilities to ensure that once the food scraps are separated by the generator they are ultimately recycled and not disposed.

Full text of the express terms, hearing information, and related information pertaining to the proposed rulemaking is available on DEC's website.

DEC will hold virtual public hearings on the proposed Part 350 regulations on Wednesday, April 7, at 1 p.m. and 6 p.m. via WebEx. The public is invited to submit written comments on the proposed regulations from Jan. 27, through April 27, 2021. Written comments can be submitted by email to FoodScrapsLaw@dec.ny.gov or by mail to: ORRS-Part 350, NYSDEC, Division of Materials Management, 625 Broadway, Albany, NY 12233-7253. Please include "Comments on Proposed Part 350" in the subject line of the email.

New York State has taken decisive action to combat food insecurity during the COVID-19 pandemic, including the launch of the Nourish

New York program statewide and a pilot partnership with HelloFresh to provide fresh meals to veterans, military families, and other residents in New York City, among other initiatives. In July, Governor Cuomo announced \$1.5 million in funding for Feeding New York State to support its network of 10 regional food banks, as well as local farms to help provide milk and produce to food insecure New Yorkers in response to the increased need for food bank services due to the economic and public health impacts of the COVID-19 pandemic. The grant built upon more than \$4.3 million announced by the Governor earlier last year for projects across the state that will help prevent hunger and reduce the disposal of food waste through food donation and recycling.

DEC Partners with University at Buffalo Researchers to Improve Waste Tire Recycling in NYS – State and UB Experts Will Work Together to Create Beneficial Uses for Millions of Waste Tires Disposed of Each Year

New York State Department of Environmental Conservation (DEC) Commissioner Basil Seggos today announced a partnership with the University at Buffalo (UB) to develop an action plan focused on the proper and cost-effective management of waste tires. Building upon the State's highly successful waste tire stockpile removal efforts, DEC and UB will work collaboratively to assess waste tire markets and develop environmentally and financially responsible ways to improve the recycling of millions of tires disposed of annually.

"New York residents and businesses generate up to 20 million waste tires each year and to achieve our state's environmental sustainability goals we must find productive reuses of the materials," Commissioner Seggos said. "DEC has already taken effective actions to address illegal tire stockpiles that created threats to public health and the environment, but we must do more to strengthen tire recycling markets and infrastructure. We welcome this partnership with UB to help reduce an abundant and challenging waste stream and recycle tires in an economically and environmentally beneficial way."

"We are excited to work with the DEC on assessing and improving tire recycling in NY state. UB's RENEW Institute is uniquely positioned to provide solutions for various aspects of tire recycling (as mentioned below) by engaging a multidisciplinary faculty team," said UB's Research and Education in Energy, Environment and Water (RENEW) Institute Director and SUNY Distinguished Professor Amit Goyal, who is also the project's director.

Tire dumps are a breeding ground for disease-bearing mosquitos and animals and cause significant air and water pollution if they catch on fire. The partnership announced today builds upon the 2003 Waste Tire Management and Recycling Act, which mandated market development for waste tires, prohibited land burial of these tires, and instituted a recycling fee on each new tire sold in New York State to fund the cleanup of noncompliant tire waste stockpiles, among other activities.

New York State remains diligent in assessing noncompliant waste tire stockpiles, prioritizing cleanup, and incorporating these tires into the State's Waste Tire Stockpile Abatement Plan. Since the plan was established in 2003, nearly 44 million tires have been abated from more than 160 noncompliant sites.

To address remaining waste tire challenges, DEC and UB will explore different options for the beneficial use of whole tires and tire byproducts other than use as fuel for waste-to-energy or refurbishing these tires for reuse on vehicles. UB will inventory and evaluate existing data, assess the current supply and demand for various forms of tire rubber in New York and across the U.S., and evaluate methods to improve waste tire recycling infrastructure and the marketability of secondary tire-based materials and products. In addition, UB will evaluate policy options that may be appropriate to promote waste tire rubber marketability and develop recycling markets for waste tires in New York. This project is funded with nearly \$250,000 primarily from the State's Waste Management and Cleanup Account, supported by the State's tire recycling fee.

For more information about waste tires, including tips on how to help make tires last longer on vehicles and to properly dispose of old tires, go to DEC's website or contact a local DEC Regional Office.

UC Executive Pat Ryan Outlines Efforts to Equitably Distribute COVID-19 Vaccine

- *Ulster County is partnering with pharmacies, faith leaders, and community leaders to ensure vaccines are provided to eligible members of our disenfranchised communities*
- *Ulster County Office for the Aging will be assisting seniors without computer access to sign up for vaccination information*
- *UCAT will offer free transportation for residents going to a vaccination appointment*

KINGSTON, N.Y. - Ulster County Executive Pat Ryan today announced a series of steps that the County is taking to ensure that the COVID-19 vaccine will be distributed equitably. While the vaccine still is not widely available to the public at-large, Ulster County is prioritizing disenfranchised individuals and continuing to work to ensure that residents that do not have access to traditional healthcare institutions have the ability to acquire the vaccine.



County Executive Ryan and Pharmacist Neil Smoller at the New Progressive Baptist Church in Kingston

“While my priority remains acquiring the needed vaccines to ramp up our vaccination efforts, Ulster County will continue to do everything within our power to ensure that the distribution of available vaccines is done in an equitable way,” Ulster County Executive Pat Ryan said. “We will continue to partner with pharmacies, members of our religious community, and other organizations to ensure that we can bring the vaccine to those most in need in a quick and fair manner.”

County Executive Pat Ryan announced that in partnership with a local pharmacy, over 200 vaccines were administered to qualifying individuals at local churches, synagogues, and senior facilities in the Kingston and Saugerties areas. Through this new partnership, additional vaccines will be administered at houses of worship in the Ellenville region next week.

In addition, County Executive Ryan has directed the Office for the Aging to assist seniors who are unable to sign up for vaccine information due to a lack of access to the internet. He also announced that by partnering with local pharmacies, the Office for the Aging Ulster County Senior Hub will soon be used as a vaccination location.

For residents in need of transportation, UCAT will be offering free rides to those with vaccination appointments. Transportation appointments must be made 24-hours in advance, by calling (845) 334-8120 between 9 a.m. to 4 p.m., Monday through Friday.

In December, County Executive Ryan established the Ulster

County Vaccine Distribution Coalition. Led by Dr. Marc Tack, an infectious disease specialist with more than 20 years of medical experience, the coalition is made up of community leaders with the goal of educating the public in order to build trust and confidence in the COVID-19 vaccine and its distribution process. The committee looks to emphasize focus on underserved populations to ensure a seamless process once the vaccine is readily available to the general public.

Currently, the COVID-19 vaccine is being rolled out to specific groups included in Phase 1a and Phase 1b outlined by New York State's Phased Distribution of the Vaccine. Individuals who fill out the form will be notified by the Ulster County Department of Health at their preferred contact information when it is your time to receive the vaccine and will be provided instructions on how to register.

For more information and questions, please visit our Ulster County COVID-19 Vaccination Resource Center: <http://vaccinateulster.com> or call the Recovery Service Center at 845-443-



Why wear a mask?

Out of respect.

When you wear a mask you are saying,
I respect my neighbors.

When you wear a mask you are saying,
I respect nurses and doctors.

When you wear a mask you are saying,
I respect other people.

We all need to show respect to one another in difficult times.

Wearing a face covering is a small inconvenience to protect others. We have gotten through this crisis by standing together and doing the right thing. The right thing - the respectful thing - is to wear a mask.

CALENDAR OF LOCAL EVENTS

- 2/3/21 Town of Neversink Planning Board Meeting 7 pm (App submission Dt. 1/20/21)
 2/4/21 Claryville Fire District 6:30 pm Warren Cole Hall in Claryville.
 2/9/21 Town of Denning Town Board and Business meeting at Denning Town Hall 6:00 pm (Please note: 2nd Tuesday)
 2/10/21 Town of Neversink Town Board Meeting - Regular
 2/15/21 **Town of Neversink Holiday - President's Day**
 2/16/21 Town of Neversink Zoning Board of Appeals 7:30 pm
 2/18/21 Town of Denning Planning Board Meeting - 6:00 pm Denning Town Hall

Save the Date!

Matthew Bertholf's 10th Anniversary Memorial Horseshoe Tournament Sunday, July 11, 2021
 Neversink Fire Department Pavilion.

TOWN OF OLIVE MEETINGS ARE AS FOLLOWS:

Unless otherwise noted, all **Town Board meetings** are held at the Town Meeting Hall, Bostock Road, Shokan at **7:00 pm.** Town Board Meetings are the **second Tuesday of each month** with the **audit/workshop meetings** being held the **Monday preceding the second Tuesday.**

Town of Olive Planning Board meets the **first and third Tuesdays of each month.** Meetings start at 7:30 PM at the Town Hall on Bostock Road, Shokan, NY. You can contact the Town Building & Zoning Department to confirm a meeting date if you would like to attend at 657-2015. If there is nothing on their agenda, they will cancel meetings.

PLEASE CONTACT A MEMBER OF EACH ORGANIZATION FOR UPDATES ON OPENINGS

Town of Denning - <http://www.denning.us>
 Town of Neversink - <https://townofneversink.org>

Ulster County Legislature Weekly Update For The Week of
February 1 - February 5, 2021

Monday, February 1

- o 5:00 PM - Public Health & Social Services Committee Powered by Zoom Meetings, Meeting ID: 925 6766 8295, By Phone Dial: (646) 558-8656
- o 6:15 PM (or immediately following the Public Health & Social Services Committee) - Energy & Environment Committee Powered by Zoom Meetings, Meeting ID: 994 0761 6659, By Phone Dial: (646) 558-8656

Tuesday, February 2

- o 10:30 AM - Ulster County Industrial Development Agency Audit Committee Powered by Zoom Meetings, Meeting ID: 816 4111 9687, By Phone Dial: (646) 558-8656
- o 11:30 AM (or immediately following the UC IDA Audit Committee) Ulster County Capital Resources Corporation Audit Committee Powered by Zoom Meetings, Meeting ID: 816 4111 9687, By Phone Dial: (646) 558-8656
- o 4:30 PM - Ulster County Economic Development Alliance Board Meeting Powered by Zoom Meetings, Meeting ID: 851 6054 4353, By Phone Dial: (646) 558-8656
- o 5:15 PM - Legislative Programs, Education & Community Services Committee Powered by Zoom Meetings, Meeting ID: 915 5695 2701, By Phone Dial: (646) 558-8656
- o 6:00 PM (or immediately following the Legislative Programs, Education & Community Services Committee) Economic Development, Tourism, Housing, Planning & Transit Committee Powered by Zoom Meetings, Meeting ID: 946 8728 8237, By Phone Dial: (646) 558-8656

Wednesday, February 3

- o 5:15 PM - Law Enforcement & Public Safety Committee Powered by Zoom Meetings, Meeting ID: 918 6610 4318, By Phone Dial: (646) 558-8656
- o 6:30 PM (or immediately following the Law Enforcement & Public Safety Committee) - Public Works & Capital Projects Committee Powered by Zoom Meetings, Meeting ID: 984 5831 8580, By Phone Dial: (646) 558-8656
- o 7:00 PM - Ulster County Planning Board Powered by Zoom Meeting. Dial (646) 558-8656, Webinar ID: 875 6300 3273 Pw: 834223

Thursday, February 4

- o 5:30 PM - Human Rights Commission Powered by Zoom Meetings, Meeting ID: 301 339 6875, By Phone Dial: (646) 558-8656

Friday, February 5

- o No Meetings

Regards,
 Jay Mahler, Deputy Clerk
 Ulster County Legislature

Tri-Valley Elementary School**WANTED:****Local establishments to display student KINDNESS artwork**

Contact Penny Hennessey in the Main Office at 985-2296 ext. 5306
 or pennyhennessey@trivalleycsd.org

All artwork and frames will be provided by the District and refreshed bi-annually.

Help your local business grow**Advertise locally in****The Townsman!**

Classified ads - \$6.00 for the first 20 words/

20 cents each additional word

1" Boxed ad (1" x 3")

- \$7.50 per week

Business card ad (2" x 3")

\$15.00 per week

(3" x 4") - \$30.00 per week

(3" x 6") - \$45.00

(4" x 6") - \$60.00

1/4 pg (4" x 5") - \$50.00

(6" x 8") - \$120.00

1/2 pg (4"x8") - \$80.00

Full Page - 8" x10" - \$160

Low Rates - High Visibility!

Attorney General James Releases Report on Nursing Homes' Response to COVID-19 – Investigations Reveal DOH Publicly Reported Data Undercounted COVID-19 Deaths and Many Nursing Homes Failed to Comply with Critical Infection Control Policies AG Conducting Ongoing Investigations into More Than 20 Facilities

NEW YORK - Attorney General Letitia James today released a report on her office's ongoing investigations into nursing homes' responses to the COVID-19 pandemic. Since March, Attorney General James has been investigating nursing homes throughout New York state based on allegations of patient neglect and other concerning conduct that may have jeopardized the health and safety of residents and employees.

Among those findings were that a larger number of nursing home residents died from COVID-19 than the New York State Department of Health's (DOH) published nursing home data reflected and may have been undercounted by as much as 50 percent. The investigations also revealed that nursing homes' lack of compliance with infection control protocols put residents at increased risk of harm, and facilities that had lower pre-pandemic staffing ratings had higher COVID-19 fatality rates. Based on these findings and subsequent investigation, Attorney General James is conducting ongoing investigations into more than 20 nursing homes whose reported conduct during the first wave of the pandemic presented particular concern.

"As the pandemic and our investigations continue, it is imperative that we understand why the residents of nursing homes in New York unnecessarily suffered at such an alarming rate," said Attorney General James. "While we cannot bring back the individuals we lost to this crisis, this report seeks to offer transparency that the public deserves and to spur increased action to protect our most vulnerable residents. Nursing homes residents and workers deserve to live and work in safe environments, and I will continue to work hard to safeguard this basic right during this precarious time."

Background

The Office of the Attorney General (OAG) is the only law enforcement agency in the state specifically mandated to investigate and prosecute abuse and neglect of residents in nursing homes. In early March, OAG received and began to investigate allegations and indications of COVID-19-related neglect of residents in nursing homes. At the direction of Governor Andrew Cuomo, on April 23, OAG set up a hotline to receive complaints relating to communications by nursing homes with family members prohibited from in-person visits to nursing homes and formally initiated a large-scale investigation of nursing homes' responses to the pandemic. OAG received more than 770 complaints on the hotline through August 3, and an additional 179 complaints through November 16. OAG also continued to receive allegations of COVID-19-related neglect of residents through pre-existing reporting systems.

Overview of Findings

The report includes preliminary findings based on data obtained in investigations conducted to date, recommendations that are based on those findings, related findings in pre-pandemic investigations of nursing homes, and other available data and analysis. Based on this information and subsequent investigation, OAG is currently conducting investigations into more than 20 nursing homes across the state. OAG found that:

o A larger number of nursing home residents died from

COVID-19 than DOH data reflected;

- o Lack of compliance with infection control protocols put residents at increased risk of harm;
- o Nursing homes that entered the pandemic with low U.S. Centers for Medicaid and Medicare Services (CMS) Staffing ratings had higher COVID-19 fatality rates;
- o Insufficient personal protective equipment (PPE) for nursing home staff put residents at increased risk of harm;
- o Insufficient COVID-19 testing for residents and staff in the early stages of the pandemic put residents at increased risk of harm;
- o The current state reimbursement model for nursing homes gives a financial incentive to owners of for-profit nursing homes to transfer funds to related parties (ultimately increasing their own profit) instead of investing in higher levels of staffing and PPE;
- o Lack of nursing home compliance with the executive order requiring communication with family members caused avoidable pain and distress; and
- o Government guidance requiring the admission of COVID-19 patients into nursing homes may have put residents at increased risk of harm in some facilities and may have obscured the data available to assess that risk.

Undercounting of COVID-19 Deaths in Nursing Homes

Preliminary data obtained by OAG suggests that many nursing home residents died from COVID-19 in hospitals after being transferred from their nursing homes, which is not reflected in DOH's published total nursing home death data. Preliminary data also reflects apparent underreporting to DOH by some nursing homes of resident deaths occurring in nursing homes. In fact, the OAG found that nursing home resident deaths appear to be undercounted by DOH by approximately 50 percent.

OAG asked 62 nursing homes (10 percent of the total facilities in New York) for information about on-site and in-hospital deaths from COVID-19. Using the data from these 62 nursing homes, OAG compared: (1) in-facility deaths reported to OAG compared to in-facility deaths publicized by DOH, and (2) total deaths reported to OAG compared to total deaths publicized by DOH.

In one example, a facility reported five confirmed and six presumed COVID-19 deaths at the facility as of August 3 to DOH. However, the facility reported to OAG a total of 27 COVID-19 deaths at the facility and 13 hospital deaths - a discrepancy of 29 deaths.

Lack of Compliance with Infection Control Policies

OAG received numerous complaints that some nursing homes failed to implement proper infection controls to prevent or mitigate the transmission of COVID-19 to vulnerable residents. Among those reports were allegations that several nursing homes around the state failed to plan and take proper infection control measures, including:

- o Failing to properly isolate residents who tested positive for COVID-19;
- o Failing to adequately screen or test employees for COVID-19;
- o Demanding that sick employees continue to work and care for residents or face retaliation or termination;
- o Failing to train employees in infection control protocols; and
- o Failing to obtain, fit, and train caregivers with PPE.

For instance, OAG received a complaint that at a for-profit nursing home located north of New York City, residents who tested positive for COVID-19 were intermingled with the general population for several months because the facility had not yet created a "COVID-19 only" unit. (Contd. Pg. 26)

Attorney General James Releases Report on Nursing Homes' Response to COVID-19

(From Pg. 25) At another for-profit facility on Long Island, COVID-19 patients who were transferred to the facility after a hospital stay and were supposed to be placed in a separate COVID-19 unit in the nursing home were, in fact, scattered throughout the facility despite available beds in the COVID-19 unit. This situation was allegedly resolved only after someone at the facility learned of an impending DOH infection control visit scheduled for the next day, before which those residents were hurriedly transferred to the appropriate designated unit. OAG received reports that nursing homes did not properly screen staff members before allowing them to enter the facility to work with residents. Among those reports, OAG received an allegation that a for-profit nursing home north of New York City failed to consistently conduct COVID-19 employee screening. It was reported that some staff avoided having their temperatures taken and answering a COVID-19 questionnaire at times when the screening station at the facility's front entrance had no employees present to take that information or when staff entered the facility through a back entrance, avoiding the screening station altogether.

At yet another facility in Western New York, a nurse reported to OAG that immediately prior to the facility's first DOH inspection in late April, a nurse supervisor had set up bins in front of the units with gowns and N95 masks to make it appear that the facility had an adequate supply of appropriate PPE for staff. The nurse alleged that the nurse supervisor came in to work unusually early the day of the first inspection and brought out all new PPE and collected all of the used gowns. Although the initial DOH survey conducted that day did not result in negative findings, DOH returned to the facility for follow-up inspections, issued the facility several citations, and ultimately placed the facility in "Immediate Jeopardy."

Nursing Home with Low Staffing Ratings Had Higher Fatality Rates

There are 619 nursing homes in New York, and 401 of these facilities are for-profit, privately owned, and operated entities. Of the state's 401 for-profit facilities, more than two-thirds - 280 nursing homes - have the lowest possible CMS Staffing ratings. The Staffing rating reflects the number of staffing hours in the nursing department of a facility relative to the number of residents. As of November 16, 3,487 COVID-19 resident deaths (over half of all deaths) occurred in these 280 facilities. Some of these facilities have also been known to transfer facility funds to owners and investors, rather than use them to invest in additional staffing to care for residents.

Pre-existing, insufficient staffing levels put residents and staff at increased risk of harm during the pandemic. As nursing home resident and staff COVID-19 infections rose during the initial wave of the pandemic, staffing absences increased at many nursing homes. As a result, already-low staffing levels decreased even further, to especially dangerous levels in some homes, even as the need for care increased due to the need to comply with COVID-19 infection control protocols and the loss of assistance from family visitors. OAG's preliminary investigations reflect many examples where for-profit nursing homes' pre-pandemic low staffing model simply snapped under the stress of the pandemic.

OAG received a complaint from a resident's son about a for-profit nursing home in New York City alleging that his mother was not receiving proper care because of critically low staffing levels at the facility. His mother was never tested for COVID-19, but later died while exhibiting COVID-19 symptoms. Between late March and early April, the facility was so understaffed due to staff quarantining, working from home, and pre-existing low staffing, that the onsite management of the entire facility was left in the hands of just two nurse supervisors. During the week of April 5, 33 residents died at that facility, 15 percent of all its residents.

In addition, preliminary investigations indicate that when there were insufficient staff to care for residents, some nursing homes pressured, knowingly permitted, or incentivized existing employees who were ill or met quarantine criteria to report to work and even work multiple consecutive shifts, in violation of infection control protocols. These policies put both residents and staff at great risk.

Immunity Provisions

Despite these disturbing and potentially unlawful findings, due to recent changes in state law, it remains unclear to what extent facilities or individuals can be held accountable if found to have failed to appropriately protect the residents in their care. On March 23, Governor Cuomo created limited immunity provisions for health care providers relating to COVID-19. The Emergency Disaster Treatment Protection Act (EDTPA) provides immunity to health care professionals from potential liability arising from certain decisions, actions and/or omissions related to the care of individuals during the COVID-19 pandemic. While it is reasonable to provide some protections for health care workers making impossible health care decisions in good faith during an unprecedented public health crisis, it would not be appropriate or just for nursing homes owners to interpret this action as providing blanket immunity for causing harm to residents.

In order to ensure no one can evade potential accountability, Attorney General James recommends eliminating these newly enacted immunity provisions.

Attorney General James encourages anyone with information or concerns about nursing home conditions to file confidential complaints online or by calling 833-249-8499.

This report is the collective product of investigative work undertaken since March 2020 by the Medicaid Fraud Control Unit's (MFCU) 275 attorneys, forensic auditors, police investigators, medical analysts, data scientists, electronic investigation team, legal assistants, and support staff in eight offices across New York. MFCU is led by Director Amy Held and Assistant Deputy Attorney General Paul J. Mahoney. MFCU is a part of the Division for Criminal Justice, which is led by Chief Deputy Attorney General for Criminal Justice José Maldonado and overseen by First Deputy Attorney General Jennifer Levy. MFCU receives 75 percent of its funding from the U.S. Department of Health and Human Services under a grant award totaling \$60,071,905 for Federal fiscal year (FY) 2019-20, of which \$45,053,932 is federally funded. The remaining 25 percent of the approved grant, totaling \$15,017,973 for FY 2019-20, is funded by New York state. Through MFCU's recoveries by means of law enforcement actions and civil enforcement actions, it regularly returns more to the state than it receives in state funding.

Attorney General James Leads Bipartisan Coalition Fighting to Protect Nearly One Million Homeowners from Unlawful Fees

Mortgage Servicing Class Action Settlement Violates Most States' Laws and Provides Windfall for Mortgage Servicer Instead of Homeowners

NEW YORK - New York Attorney General Letitia James today co-led a bipartisan coalition of 33 attorneys general in opposing a proposed class action settlement that would permit a mortgage servicer to profit from illegal payment processing fees charged to homeowners making normal mortgage payments online or by phone. Attorney General James co-leads the coalition in filing a motion for leave to file an amicus brief, opposing the proposed settlement in *Morris et al. v. PHH Mortgage Corporation, et al.*, where mortgage servicer PHH Mortgage Corporation and its predecessor corporation, Ocwen Loan Servicing, LLC (collectively PHH), would be able to continue to profit from illegal processing fees the company has been charging to nearly one million homeowners nationwide, including more than 74,000 homeowners residing in New York state alone.

“When Americans utilize online or phone payments to pay off their monthly mortgages, PHH benefits, but instead of passing those savings on to homeowners PHH charged illegal fees and increased costs for nearly one million Americans,” said Attorney General James. “PHH's sole purpose is to collect and process homeowners' payments, which it already makes millions of dollars from each year. In the 21st century, when most Americans pay their bills online or by phone, to charge fees on top of what they are already being paid is not only unethical, but unlawful. A bipartisan coalition is standing up and fighting back against this backwards settlement because we will always fight to protect the wallets of our states' residents.”

For years, PHH charged nearly one million homeowners an illegal fee - ranging from \$7.50 to \$17.50 - each time a homeowner made a monthly mortgage payment online or by phone, despite most (Contd. Pg. Americans paying their mortgages one of these two ways. Nowhere in these homeowners' mortgage contracts is there authorization for such fees and PHH does not charge “processing” fees for any other customers, including those who pay by check or those who set up automatic debit payments. Charging fees not mentioned in the mortgage contract is illegal and, under New York's mortgage servicing regulations, explicitly forbidden.

Under the terms of PHH's proposed settlement - which was hastily entered into only five months after the complaint was filed - PHH will not only be permitted to continue to charge these illegal fees, but will be able to actually increase fees - up to \$19.50 per month - for the remaining life of the loan, which, for many homeowners, could be another 20 to 30 years. In exchange, homeowners will receive a paltry, and for some, illusory, one-time monetary payment. Further, the proposed settlement seeks to authorize these unlawful fees through an unwritten, mass amendment of the mortgages - a violation of most states' statutes of frauds, a centuries old legal doctrine that requires contracts related to property to be in writing and signed by the parties. This unwritten, mass amendment also means PHH will evade many states' recording requirements for modified mortgages, resulting in confusion and enabling PHH to avoid state and local recording fees.

Additionally, Attorney General James leads the coalition in objecting to the inadequacy of the monetary relief, as the proposed settlement is designed to ensure that a portion of the monetary relief intended for homeowners will actually end up in

PHH's hands. Homeowners whose loans are still serviced by PHH will not receive any direct monetary payments for prior unlawful payments received by PHH. Instead, these homeowners will only receive a credit to their account that will only be applied to the unpaid principal balance of the mortgage after any late fees are first paid - costing homeowners more in the end. Moreover, any settlement funds not distributed to the class member homeowners will be returned to PHH, ensuring the settlement further benefits PHH and not impacted class members.

Gillibrand Announces Keep Our Pact Act to Support Low-income Students and Students with Disabilities

Bicameral Keep Our Promise to America's Children and Teachers (PACT) Act Would Fully Fund Title I and the Individuals with Disabilities Education Act (IDEA)

WASHINGTON, D.C - U.S. Senator Kirsten Gillibrand announced bicameral legislation to support educational programs for low-income students and students with disabilities. The Keep Our Promise to America's Children and Teacher's (PACT) Act would put Congress on a fiscally-responsible path to provide mandatory funding for Title I and the Individuals with Disabilities Education Act (IDEA). School closures and remote learning during the pandemic have already impeded educational progress for millions of students, especially those in need of additional support. Now more than ever, lower income students and students with disabilities are at risk of falling even further behind as the pandemic has drained resources for cash-strapped schools and districts, and reduced access to valuable educational support programs. The Keep Our PACT Act would mandate funding of key programs that support students in lower-income school districts and students with disabilities, reduce inequities in the education system, and ensure all students receive a quality education. The bill was introduced in the Senate by U.S. Senator Chris Van Hollen (D-MD) and in the House by U.S. Representative Susie Lee (D-NV).

“The pandemic has exacerbated inequalities in our schools and made the learning gap even harder to overcome for students in need. We must prioritize ensuring all children have access to high-quality education, regardless of their zip code” said Senator Gillibrand. “It is critical that Congress finally make good on our promise to underserved children, parents, and educators across New York. I have been fighting to support our schools throughout this crisis and I will continue working with my colleagues, and the new administration, on this investment in our future.”

The Keep Our PACT Act would create a 10-year mandatory plan to fully fund both Title I and IDEA, ensuring that education is a priority in the federal budget. Title I gives assistance to America's highest-need schools and is a critical tool to ensure that every child, no matter the zip code, has access to a quality education. However, it has been deeply underfunded, short-changing our most vulnerable students living in poverty. According to the National Education Association (NEA), the Title I funding gap for school year 2019-2020 was over \$29 billion. Similarly, IDEA calls on the federal government to fund 40% of the cost of special education, but Congress has never fully funded the law. According to the NEA, IDEA state grants are currently funded at just 13.8% - the lowest percentage since 2000.

Governor Cuomo Reminds New Yorkers They are not Responsible for Paying PPE Charges from In-Network Health Care Providers

Health and Dental Insurers Must Ensure Consumers Are Not Charged PPE Fees by In-Network Providers

New Yorkers Wrongfully Charged for PPE by In-Network Providers Are Eligible for Refund

To date, Department of Financial Services Has Secured More Than \$400K in Restitution

Governor Andrew M. Cuomo today reminded insured New Yorkers that they should not be charged for Personal Protective Equipment by in-network healthcare providers under their state-regulated health and dental insurance coverage. Pursuant to State Department of Financial Services guidance, insurers are required to make sure that consumers are not charged PPE-related fees by in-network providers. New Yorkers who have been wrongfully charged are eligible for refund from their insurer. To date, the Department has recovered a total of \$414,727 of PPE-related charges for more than 14,000 consumers since the start of the pandemic.

"While we continue to fight the war on COVID, PPE remains a critical tool to keeping the infection rate down and keeping New Yorkers safe until we reach herd immunity," Governor Cuomo said. "COVID-19 has dealt a financial blow to far too many New Yorkers, and they should never be responsible for the cost of critical PPE in the middle of a pandemic, especially when seeing their regular health care providers. New York will continue putting in place comprehensive protections to help ensure consumers are not wrongfully charged PPE-related fees and will take aggressive action to help recover any supplemental fees incurred."

Superintendent of Financial Services Linda A. Laceywell said, "New Yorkers are already facing some of the worst financial hardships due to the pandemic. DFS issued the circular letter to insurers to make sure consumers are not responsible for fees that go beyond their financial obligation. As we move forward during these uncertain times, we appreciate the efforts insurers have made throughout this pandemic and encourage healthcare providers and insurers to continue to work together so patients receive the care they need without extra charges."

The guidance, issued August 5, 2020, recommended that insurers:

- o Immediately notify their participating providers not to charge PPE fees and that insureds should be held harmless for these charges;
- o Instruct providers to refund PPE fees to insured persons;
- o Notify insured persons that they should not be charged for PPE fees and provide insureds with insurers' contact information to submit related complaints;
- o Work with their providers to resolve issues relating to increased costs due to COVID-19, including PPE fees, so insured persons are held harmless for these fees, which may require that insurers request information from providers about whether insured persons were charged improper fees; and
- o Work with their providers to ensure that refunds are provided to insured persons; and
- o Within 90 days of the circular letter, report to DFS the amount of PPE fees charged to insureds, the number of insureds impacted, and a description of how refunds will be provided.

New Yorkers with complaints about an insurance policy can contact DFS at www.dfs.ny.gov/complaint or through the DFS Consumer Hotline at (212) 480-6400 or (518) 474-6600 (Monday through Friday, 8:30 AM to 4:30 PM).

Senator Martucci Joins Senate Republicans to Unveil "Reset NY's Restaurant & Hospitality Industry" Legislation

Martucci Bill Creates

Small Business Relief Fund

Albany, NY (January 26, 2021) - Senator Mike Martucci (R, C, I - New Hampton), along with his colleagues in the Senate Republican Conference, today unveiled a package of legislation to help "Reset New York's Restaurant and Hospitality Industry."

New York State's economy has been devastated by the COVID-19 pandemic, particularly the restaurant and hospitality industries. Many small businesses in the Senator's district - from the exurbs of New York City to the Upper Delaware - include generational and Main Street establishments as well as one-of-a-kind experiences found exclusively in the Hudson Valley and Catskills. Additionally, nearby New York City's restaurants and hospitality businesses employ thousands of people living upstate, provide a market for the region's agriculture industry, and serve as a destination for intrastate commerce and tourism.

Since the onset of the pandemic, the industries' woes have greatly contributed to the state's steep unemployment rate and distressed sales tax revenues. The hospitality industry is the number two source of sales tax receipts in the state and the number three employer, according to data from 2019. A December study by the National Restaurant Association showed that 54% of our restaurants said they would likely have to close in the next six months, giving a clear sense of New York State's bleak outlook. Already, over 1,000 restaurants in New York City have closed their doors for good. Because of the state's failed leadership leading up to the pandemic, the cracks in its economic foundation were exposed greater in no other place.

As if the shutdowns and anti-business policies of the state were not enough, the New York State Liquor Authority (SLA) and other state agencies cracked down on bars and. Hundreds of bars have been cited for myriad small violations, including measures which are unsubstantiated by scientific evidence, such as dining past 10 PM. Real violations should be treated with the proper scrutiny and conviction if guilty; however, when government policy causes businesses to fail, the government has a duty to its citizens to remedy the situation, not worsen it.

Senator Martucci's piece of legislation in this wide-ranging package is an attempt to take one of the most negative and controversial actions the state has pursued against restaurants and bars during the pandemic and turn it into a positive. His bill would redirect any fines and fees collected by the SLA from establishments in the hospitality industry into a Small Business Relief Fund. The newly created Small Business Relief Fund would become an important tool for helping those in the industry who have followed state guidance to get back on their feet as the state's recovery begins to take shape.

"I know firsthand how hard it is to run a business in this state. Since the pandemic began pressure on our small businesses - particularly on the restaurant and hospitality industry and their employees - has only increased, making a bad situation much worse. This package of bills will provide exactly the kind of relief needed at this critical moment. I urge our colleagues in the Senate majority to get serious about helping small businesses, along with their employees, and allow a vote on these measures immediately," said Senator Mike Martucci. (Contd. Pg. 29)

Senator Martucci Joins Senate Republicans to Unveil “Reset NY's Restaurant & Hospitality Industry” Legislation

Martucci Bill Creates Small Business Relief Fund

(From Pg. 28) The cornerstone of the package of legislation advanced by the Senate Republicans today includes a comprehensive bill, sponsored by Senator George Borrello (SD 57), to provide relief to business owners and employers affected by the COVID-19 pandemic. The bill would:

- Exempt small businesses from being penalized with higher unemployment insurance rates due to layoffs resulting from COVID-related, government-mandated closures. The exemption would extend for a period of one year from when they are permitted to return to full capacity;
- Prohibit internet-based food delivery services from charging higher fees than they charged on or before March 1, 2020;
- Provide small businesses additional time to pay monthly sales and payroll taxes, as well as, business and property taxes;
- Offer interest-free loans or lines of credit to small businesses;
- Provide a one year extension for renewal of liquor licenses; and
- Provide businesses a 90 day grace period to pay any fees or penalties due to state and local agencies.

Also included in the plan announced by the Senate Republican Conference were pieces of legislation that would:

- Direct SLA-inflicted fines into a business relief fund to help small businesses get back on their feet (Senator Mike Martucci, SD 42);
- Provide for a credit on liquor license renewals for the amount of time bars and restaurants were forced to be shut down due to the COVID-19 pandemic (Senator Joseph Griffo, SD 47);
- Create a limited state sales tax exemption for the sale of food and drink at restaurants and taverns from state sales and compensating use taxes and granting municipalities the option to grant such limited exemption (Senator Daphne Jordan, SD 43);
- Provide a tax check off box that will direct funds into a business relief fund (Senator Mario Mattera); and
- Create an employee retention tax credit, modeled after the Federal Employee Retention Credit, to help employers keep workers on payroll (Senator Peter Oberacker, SD 51).

COVID-19 Update from Governor Cuomo

We're using the limited supply of vaccines as efficiently as possible and continuing to stop the spread of the virus and we're also focused on safely getting the economy back on track while safeguarding public health. The restaurant industry is the lifeblood of New York City and we are all too aware of the economic hardship they have endured at the hands of COVID. Thankfully, if our current trajectory holds, we will be able to reopen New York City dining at 25 percent capacity on February 14th, Valentine's Day. Additionally, other larger events that follow strict guidelines will be permitted beginning March 15th. We cannot become complacent now—we must all continue to do our

part to keep beating back COVID. Our collective actions determine how quickly we can return to some of what we've missed throughout this pandemic.

Effective March 15th, marriage receptions can be held under limited state guidelines. Events must be approved by the local health department and there will be mandatory testing of all guests before an event. Capacity at weddings and receptions will be limited to no more than 150 people or no more than 50 percent of the venue's capacity, whichever is lower. All patrons must be tested prior to the event. This upcoming change in guidelines follows the success of the Buffalo Bills program, which allowed fans to attend home games with mandatory testing.

A reminder that New Yorkers should not be charged for Personal Protective Equipment by in-network health care providers under their state-regulated health and dental insurance coverage. Pursuant to State Department Financial Services guidance, insurers are required to make sure that consumers are not charged PPE-related fees by in-network providers. New Yorkers who have been wrongfully charged are eligible for a refund from their insurer. To date, the Department has recovered a total of \$414,727 of PPE-related charges for more than 14,000 consumers since the start of the pandemic.

DEC Now Accepting Applications for Hudson Estuary 'Trees for Tribs' Program

Application Deadline March 1

New York State Department of Environmental Conservation (DEC) Commissioner Basil Seggos today announced that DEC's Hudson Estuary Trees for Tribs Program is accepting applications for spring streamside planting projects. Anyone that owns or manages property near a stream in the Hudson River Estuary watershed (PDF) is eligible to apply for free native trees and shrubs. The application deadline is March 1. Early applications are encouraged, particularly for large sites (more than 60 plants) or when requesting specific plant species.

"Streamside plantings stabilize stream banks, reduce erosion, slow floodwaters, and provide critical habitat for fish and wildlife," said Commissioner Seggos. "Trees also absorb carbon dioxide from the atmosphere, making them a powerful tool in the fight against climate change. With the assistance of hundreds of volunteer partners in the Trees for Tribs program, DEC's tree planting efforts are creating natural buffers to protect the Hudson River and its tributaries."

If a project is selected, the applicant must recruit volunteers for planting and maintain the site after the planting is complete. With certain projects, DEC staff may assist with plant selection, planting plan, site preparation, and other assistance to help projects succeed. The Colonel William F. Fox Memorial Saratoga Tree Nursery provides the plants, which are native, New York seed-sourced riparian species, ideal for flood- and erosion-prone areas.

A list of Trees for Tribs Programs in other New York watersheds is available on the DEC website.

To download an application, learn more about Hudson Estuary Trees for Tribs, or to watch a video about Trees for Tribs on DEC YouTube, visit DEC's Hudson Estuary Trees for Tribs website.

Now celebrating its 13th year, 7,300 Hudson Estuary Trees for Tribs volunteers have planted more than 57,000 shrubs and trees at 365 sites spanning over 25 miles of streams



GRAHAMSVILLE REALTY
 New York State Licensed Real Estate Broker
 135 Peekamoose Road
 Sundown, NY 12740
 grahamsvillerealty@yahoo.com
<http://www.grahamsvillerealty.com>
 845-985-0501 • 845-798-9853

HONEY FOR SALE

B & D Apiary's
 100% New York Honey
 Jeffersonville, NY 12748
 Bob 845-551-8081 or
 Don 845-807-1036

HELP WANTED

Typist-Computer Full/Part time. Work in
 Grahamsville. Call: William Brenner,
 Attorney (845) 985-7411; FAX 985-0274
 Email: williamabrenner@hotmail.com

FOR SALE

Raymour and Flanigan
Electric Lift Chair. (Gold color).
 Like new. \$150.00
 Call 845-647-7411

\$1 Reader Ads are Back!
\$1 Reader Ads may be the solution to this
 year's spring cleaning. If you have an article(s)
 you want to sell, send along a description (20
 words or less) along with \$1 for each item you
 wish to advertise for one week. If you wish to
 advertise for more than 1 week, just send \$1
 more for every week you want your item adver-
 tised. Mail to: **The Townsman, P O Box 32,**
Grahamsville, NY 12740 - or you can email us
your item description, and we will get in the
next issue of *The Townsman* and send you a
bill via your email.

Join the virtual world
 and have some fun!

Sell your handcrafted items
 online from your own
 little virtual shop
 at the Gnome Home Mall
 Interested? Send an email to:
thegnomehome@yahoo.com
Visit: <http://www.gnomehome.net>
 ... a virtual mall supported by local
 artists and crafters



**KNARF'S CLASSIC
 MOVIES & TRIVIA**
 "ON AMAZON PRIME"
WATCH
"LOVE AND MONSTERS"
 (Action, Adventure, Comedy [CC] PG-13)
<https://www.amazon.com/Love-Monsters-Dylan-O'Brien/dp/B08KSHQKQH>

Far in the future in a monster-infested world, Joel
 (Dylan O'Brien) learns his high school sweetheart (Jessica Henwick) is just
 about 80 miles away.



Now, Joel must discover his inner hero, facing unknown dangers on the
 impossible route of a hero's journey, to be with the girl of he loves. *Love
 and Monsters* is set seven years after the *monster apocalypse* with 95% of
 the world's population gone. It follows Joel Dawson who leaves his colony
 to travel approximately 80 miles to get to his high school sweetheart's
 colony. Along the way he meets an Australian kelpie named *Boy* who helps
 him along the journey. Directed by Michael Matthews, and Starring Dylan
 O'Brien, Jessica Henwick, Michael Rooker (Contd. Pg. 31)

Business Cards •
Door Hangers •
Post Cards •
Brochures •
Banners •
Flyers •

Envelopes
500 FREE
 with minimum
 purchase
 of \$25.00

SPS SENTINEL PRINTING SERVICES

WE OFFER FULL COLOR PRINTING
 at great prices
 PH: 845-562-1218
 Fax: 845-562-0488
 E-Mail: sps.printco@gmail.com

We can Print Your Artwork,
 or Let Us Custom Design
 Your Printing Needs With
 Our Experienced Designers!

Get the service you need and keep your dollar local

(From Pg. 30)

KNARF'S CLASSIC MOVIE

Ma Rainey's Black Bottom

STREAMING ON: NETFLIX

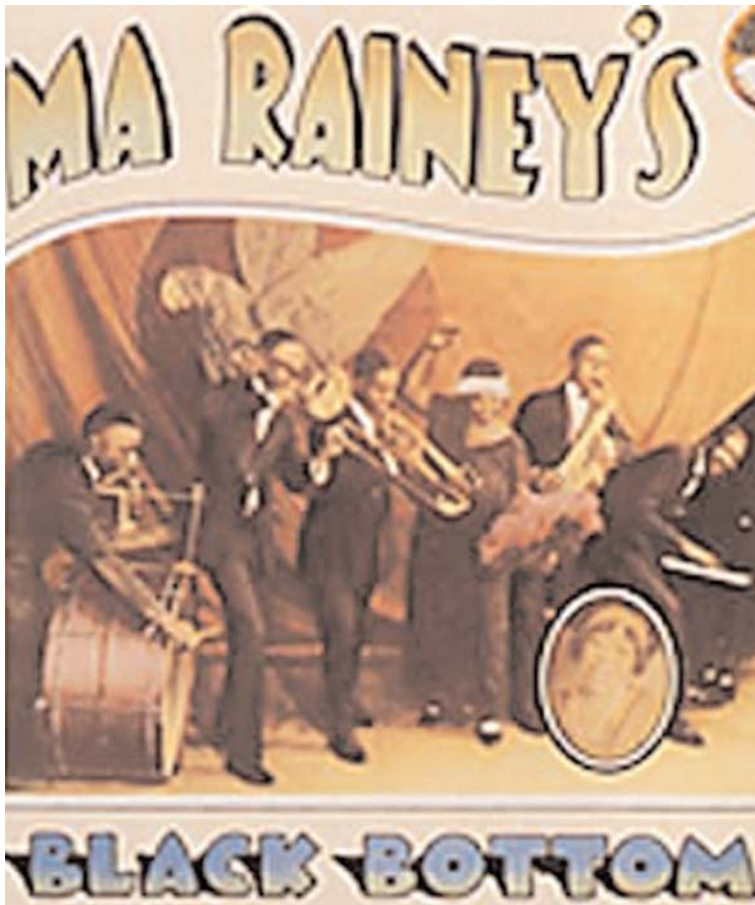

Written by Ruben Santiago-Hudson, and Directed by George C. Wolfe, starring Viola Davis, Chadwick Boseman, Glynn Turman, Colman Domingo, and Michael Potts, Oscar



winning performances, that could land them Best Actress and Best Actor Oscars, you need to catch them on Netflix movie **"Ma Rainey's Black Bottom"** is based on the stage play by August Wilson, the film takes place during a recording session for iconic **Blues singer Ma Rainey (Viola Davis) in 1920s Chicago**, as she butts heads with talented and **ambitious trumpeter Levee Green (Chadwick Boseman)**. **Davis and Boseman both deliver phenomenal performances** respectively, and while the film itself feels a little stage-y it's no less compelling. If you're in the mood for superb acting, in a showcase that also serves as Boseman's final onscreen appearance, check this one out.

KNARF'S CLASSIC MOVIES

STREAMING ON: NETFLIX

"Mank"<https://www.netflix.com/title/81100780>

Why was "Citizen Kane" made the way it was? *Mank*, written by Jack Fincher, and Directed by David Fincher. Starring Gary Oldman, Amanda Seyfried, Lily Collins, Tom Pelphrey, and Charles Dance.

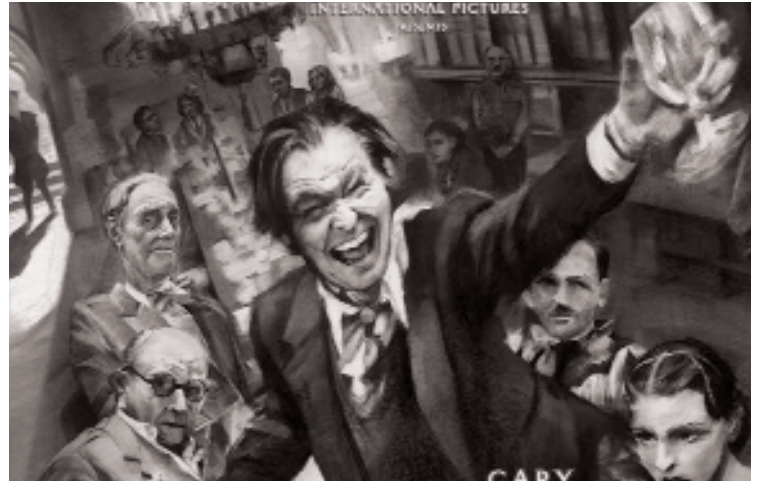

If you love classic films this one by the legendary filmmaker David Fincher takes 1930s Hollywood by storm in his Netflix original film "Mank." Directed by David Fincher it's a film spanning the 1940's world of Herman J. Mankiewicz (Gary Oldman) who is hiding while writing his screenplay for what will become *Citizen*



Kane, Flashbacks throughout the 30s show Mank's life experiences that inspire his exciting script. I say, you need to love classic films because *Mank* doesn't really treat its audience lightly when it comes to the historical figures who inhabit the various backlot sequences. But for those who are reasonably knowledgeable about 30s and 40s Hollywood studio system and the figures that inspired *Citizen Kane*,

you'll find this a rewarding watch. Even on a pure technical level, the film is presented as if it were made in the 30s, and it's pretty astounding

Stay safe, May God Bless

Knarf Odnamoc

Gnomz